

ECS-9771 USER

Intel® Xeon® / Core™ i7 4-port SFP+ 10 GigE Embedded System
Workstation-grade, High Performance, EN50155, EN50121-3-2

Manual

Record of Revision

Version	Date	Page	Description	Remark
1.0	04/18/2017	All	Official Release	
1.1	03/22/2021	3, 13	Update	

Disclaimer

This manual is released by Vecow Co., Ltd. for reference purpose only. All product offerings and specifications are subject to change without prior notice. It does not represent commitment of Vecow Co., Ltd. Vecow shall not be liable for direct, indirect, special, incidental, or consequential damages arising out of the use of the product or documentation or any infringements upon the rights of third parties, which may result from such use.

Declaration of Conformity

FCC This equipment has been tested and found to comply with the limits for a Class A digital device, pursuant to part 15 of the FCC Rules. These limits are designed to provide reasonable protection against harmful interference when the equipment is operated in a commercial environment. This equipment generates, uses, and can radiate radio frequency energy, and if it is not installed and used in accordance with the instruction manual, it may cause harmful interference to radio communications. Operation of this equipment in a residential area is likely to cause harmful interference in which case the user will be required to correct the interference at his own expense.

CE The products described in this manual complies with all applicable European Union (CE) directives if it has a CE marking. For computer systems to remain CE compliant, only CE-compliant parts may be used. Maintaining CE compliance also requires proper cable and cabling techniques.

Copyright and Trademarks

This document contains proprietary information protected by copyright. No part of this publication may be reproduced in any form or by any means, electric, photocopying, recording or otherwise, without prior written authorization by Vecow Co., Ltd. The rights of all the brand names, product names, and trademarks belong to their respective owners.

Order Information

Part Number	Description
ECS-9771-505M	ECS-9700, Quad Core Intel® Xeon® E3-1505M v5, 6 GigE LAN w/4 PoE ⁺ , 4 10G SFP+, 2 SSD Tray, 6 USB 3.0, 4 COM, 4 SIM, 32 Isolated DIO
ECS-9771-820Q	ECS-9700, Quad Core Intel® Core™ i7-6820EQ, 6 GigE LAN w/4 PoE ⁺ , 4 10G SFP+, 2 SSD Tray, 6 USB 3.0, 4 COM, 4 SIM, 32 Isolated DIO
ECS-9771-440Q	ECS-9700, Quad Core Intel® Core™ i5-6440EQ, 6 GigE LAN w/4 PoE ⁺ , 4 10G SFP+, 2 SSD Tray, 6 USB 3.0, 4 COM, 4 SIM, 32 Isolated DIO

Order Accessories

Part Number	Description
DDR4 16G	Certified DDR4 16GB 2133MHz RAM
DDR4 8G	Certified DDR4 8GB 2133MHz RAM
DDR4 4G	Certified DDR4 4GB 2133MHz RAM
PWA-280WB-WT	280W, 24V, 85V AC to 264V AC Power Adapter with 3-pin Terminal Block (7.62mm pitch), Wide Temperature -30°C to +70°C
PWA-160WB-WT	160W, 24V, 85V AC to 264V AC Power Adapter with 3-pin Terminal Block (7.62mm pitch), Wide Temperature -30°C to +70°C
VESA Mount	VESA Mounting Kit
DIN-RAIL	DIN Rail Kit
TMK2-20P-100	Terminal Block 20-pin to Terminal Block 20-pin Cable, 100cm
TMK2-20P-500	Terminal Block 20-pin to Terminal Block 20-pin Cable, 500cm
TMB-TMBK-20P	Terminal Board with One 20-pin Terminal Block Connector and DIN-Rail Mounting
3G Module	Mini PCIe 3G/GPS Module with Antenna
4G Module	Mini PCIe 4G/GPS Module with Antenna
WiFi & Bluetooth Module	Mini PCIe WiFi & Bluetooth Module with Antenna

Table of Contents

CHAPTER 1	GENERAL INTRODUCTION	1
1.1	Overview	1
1.2	Features	2
1.3	Product Specification	2
1.3.1	Specifications of ECS-9771	2
1.4	Supported CPU List	5
1.5	Mechanical Dimension	6
1.5.1	Dimensions of ECS-9771	6
CHAPTER 2	GETTING TO KNOW YOUR ECS-9771	7
2.1	Packing List	7
2.2	Front Panel I/O & Functions	7
2.3	Rear Panel I/O & Functions	16
2.4	Main Board Expansion Connectors	24
2.5	Main Board Jumper & Deep Switch Settings	38
2.6	Ignition Control	43
CHAPTER 3	SYSTEM SETUP	47
3.1	How to Open Your ECS-9771	47
3.2	Installing DDR4 SO-DIMM Modules	50
3.3	Installing Mini PCIe Card	51
3.4	Installing CFast Card	52
3.5	Installing SIM Card	53
3.6	Installing SSD/HDD	54
3.7	Mounting Your ECS-9771	56

CHAPTER 4 BIOS SETUP	61
4.1 Entering BIOS SETUP	61
4.2 Main	62
4.3 Advanced	62
4.4 Chipset	72
4.5 Security	77
4.6 Boot	78
4.7 Save & Exit	79
APPENDIX A : Isolated DIO Guide	80
APPENDIX B : Software Functions	83
APPENDIX C : RAID Installation Guide	87
APPENDIX D : Power Consumption	91
APPENDIX E : Supported Memory & Storage List	93

1

GENERAL INTRODUCTION

1.1 Overview

Vecow ECS-9771 is a performance-driven all-in-one integrated embedded system. With workstation-grade Intel® Xeon®/Core™ processor (Skylake-H) and Intel® CM236 chipset, dual channel DDR4 2133MHz up to 32GB ECC memory, ECS-9771 delivers up to 26% CPU performance improved than former generations with max 80% lower CPU power consumption; advanced Intel® HD Graphics P530/530 graphics engine supports DirectX 12, OpenGL 4.2 and OpenCL 2.0 API, dual DisplayPort and DVI-I display interfaces support up to Ultra HD 4K resolution, ECS-9771 offers up to 22% improved graphics performance than the former generation; Multiple 10 GigE (10Gbps), SATA III (6Gbps), USB 3.0 (5Gbps), PoE (1Gbps) LAN and wireless connections make high-speed data conveying possible. Vecow ECS-9771 Embedded System brings you leading workstation-grade system performance for mission critical demanding workloads.

Armed with 4-port 10 GigE SFP+ Fiber LAN, 6 independent GigE LAN supporting 4-port IEEE 802.3at (25.5W/48V) PoE+ without additional power connections, 4 SIM card sockets (3 front-access, 1 internal) for WiFi/3G/4G/LTE/GPRS/UMTS, 2 Front-access 2.5" SSD trays, 1 Front-access CFast socket, 6 external USB 3.0, 4 SATA III support software RAID function, 4 COM RS-232/422/485, 4 Mini PCIe/mSATA sockets, 32 Isolated DIO for smart circuit protection, 6V to 36V wide range power input with 80V Surge protection, configurable ignition power control, smart remote management features, remote power switch, EN50155 and EN50121-3-2 compliant, all-in-one fanless for -40°C to 55°C operating temperature, Vecow ECS-9771 10 GigE Fanless Embedded System features leading data transfer rate, multiple I/O, industrial-grade reliability and all-in-one integrated functions for any workstation-oriented embedded applications.

Gathering workstation-grade system performance, all-in-one integrated features, smart manageability, excellent mobile availability, secure power protection and industrial-grade reliability, Vecow ECS-9771 10 GigE Fanless Embedded System is your ideal solution for Machine Vision, Robot Control, Traffic Vision, Embedded Workstation, Vehicle Computing, ITS, Energy Management and any real-time IIoT/Industry 4.0 embedded applications.

1.2 Features

- 4-port 10 GigE SFP+ Fiber LAN, up to 10Gbps data rate
- Quad Core Intel® Xeon®/Core™ i7 Processor (Skylake-H) with CM236 Chipset
- 6 Independent GigE LAN with 4 IEEE 802.3at PoE⁺
- DDR4 2133MHz Memory, up to 32GB (ECC/Non-ECC)
- Fanless, -40°C to 55°C Operating Temperature
- 4 SIM Card Socket for 3G/4G/LTE/WiFi/GPRS/UMTS
- VGA, DVI-D and 2 DisplayPort interfaces, up to 3 independent HD displays
- External-access : 2 2.5" SSD Tray, 3 SIM, 6 USB 3.0, 1 CFast, 4 COM
- 32 Isolated DIO, 4 Mini PCIe/mSATA
- 6V to 36V DC-in with 80V Surge Protection
- Configurable Ignition Power Control

1.3 Product Specification

1.3.1 Specifications of ECS-9771

System	
Processor	Quad Core Intel® Xeon® E3-1505M v5/Core™ i7-6820EQ/ i5-6440EQ Processor (Skylake-H)
Chipset	Intel® CM236
BIOS	AMI
SIO	IT8786E
Memory	<ul style="list-style-type: none"> • DDR4 2133MHz • Up to 32GB • 2 260-pin SO-DIMM Socket (ECC/Non-ECC)
I/O Interface	
Serial	4 COM RS-232/422/485 with auto flow control (ESD 8KV)
USB	<ul style="list-style-type: none"> • 6 USB 3.0 (External) • 1 USB 2.0 (Internal)
Isolated DIO	32 Isolated DIO (16 DI, 16 DO)
LED	Power, HDD, Wireless, PoE, SFP+
SIM Card	4 SIM Card Socket (3 External, 1 Internal)
Expansion	
Mini PCIe	4 Mini PCIe Socket : <ul style="list-style-type: none"> • 3 Full-size for PCIe/USB/External SIM Card/mSATA • 1 Full-size for PCIe/Internal SIM Card/mSATA

Graphics	
Graphics Processor	<ul style="list-style-type: none"> • Intel® HD Graphics P530/530
Interface	<ul style="list-style-type: none"> • VGA : Up to 1920 x1200 @ 60 Hz • DVI-D : Up to 1920 x 1200 @ 60Hz • DisplayPort 1 : Up to 4096 x 2304 @ 60Hz • DisplayPort 2 : Up to 4096 x 2304 @ 60Hz
Storage	
SATA	4 SATA III support software RAID 0, 1, 5, 10 : <ul style="list-style-type: none"> • 3 SATA III (6Gbps) • 1 SATA III co-lay with Mini PCIe (6Gbps)
mSATA	4 mSATA connection : <ul style="list-style-type: none"> • 3 SATA III (Mini PCIe Type, 6Gbps) • 1 SATA III co-lay with SATA (Mini PCIe Type, 6Gbps)
Storage Device	<ul style="list-style-type: none"> • 1 CFast Socket, Push-in/Push-out Ejector • 2 Front-access 2.5" SSD/HDD Tray
Audio	
Audio Codec	Realtek ALC888S-VD, 7.1 Channel HD Audio
Audio Interface	1 Mic-in, 1 Line-out
Ethernet	
LAN 1	Intel® I219 GigE LAN supports iAMT 11.0
LAN 2	Intel® I210 GigE LAN
PoE	
LAN 3	GigE IEEE 802.3at (25.5W/48V) PoE+ by Intel® I210
LAN 4	GigE IEEE 802.3at (25.5W/48V) PoE+ by Intel® I210
LAN 5	GigE IEEE 802.3at (25.5W/48V) PoE+ by Intel® I210
LAN 6	GigE IEEE 802.3at (25.5W/48V) PoE+ by Intel® I210
10G Ethernet	
LAN 7	Intel® X710-BM2 10 GigE LAN supports IEEE 802.3 10GBASE-T SFP+
LAN 8	Intel® X710-BM2 10 GigE LAN supports IEEE 802.3 10GBASE-T SFP+
LAN 9	Intel® X710-BM2 10 GigE LAN supports IEEE 802.3 10GBASE-T SFP+
LAN 10	Intel® X710-BM2 10 GigE LAN supports IEEE 802.3 10GBASE-T SFP+

Power	
Input Voltage	6V to 36V, DC-in
Power Interface	3-pin Terminal Block : V+, V-, Frame Ground
Ignition Control	16 Mode (Internal)
Remote Switch	3-pin Terminal Block : On, Off, IGN
Surge Protection	Up to 80V/1ms Transient Power
Others	
TPM	Optional Infineon SLB9665 supports TPM 2.0, LPC interface
Watchdog Timer	Reset : 1 to 255 sec./min. per step
Smart Management	Wake on LAN, PXE supported
HW Monitor	Monitoring temperature, voltages. Auto throttling control when CPU overheats.
Software Support	
OS	Windows 10, Windows 8.1, Windows 7, Linux
Mechanical	
Dimensions (WxDxH)	260mm x 215mm x 79mm (10.2" x 8.5" x 3.1")
Weight	4.0 kg (8.82 lb)
Mounting	<ul style="list-style-type: none"> • Wallmount by mounting bracket • DIN Rail Mount (Optional) • 2U Rackmount (Optional)
Environment	
Operating Temperature	-40°C to 55°C (-40°F to 131°F)
Storage Temperature	-40°C to 85°C (-40°F to 185°F)
Humidity	5% to 95% Humidity, non-condensing
Relative Humidity	95% at 55°C
Shock	<ul style="list-style-type: none"> • IEC 60068-2-27 • SSD : 50G @ Wallmount, Half-sine, 11ms
Vibration	<ul style="list-style-type: none"> • IEC 60068-2-64 • SSD : 5Grms, 5Hz to 500Hz, 3 Axis
EMC	CE, FCC, EN50155, EN50121-3-2

1.4 Supported CPU List

Processor No.	TDP	Cache	Max. Frequency	Embedded
Xeon® E3-1575M v5	45W	8M	Up to 3.00 GHz	
Xeon® E3-1545M v5	45W	8M	Up to 2.90 GHz	
Xeon® E3-1535M v5	45W	8M	Up to 2.80 GHz	
Xeon® E3-1515M v5	45W	8M	Up to 2.80 GHz	
Xeon® E3-1505M v5	45W	8M	Up to 2.80 GHz	Yes
Xeon® E3-1505L v5	25W	8M	Up to 2.00 GHz	
Core i7-6970HQ	45W	8M	Up to 3.70 GHz	
Core i7-6920HQ	45W	8M	Up to 3.80 GHz	
Core i7-6870HQ	45W	8M	Up to 3.60 GHz	
Core i7-6820HQ	45W	8M	Up to 3.60 GHz	
Core i7-6770HQ	45W	6M	Up to 3.50 GHz	
Core i7-6700HQ	45W	6M	Up to 3.50 GHz	
Core i7-6820EQ	45W	8M	Up to 3.50 GHz	Yes
Core i7-6822EQ	25W	8M	Up to 2.80 GHz	
Core i5-6440HQ	45W	6M	Up to 3.50 GHz	
Core i5-6350HQ	45W	6M	Up to 3.20 GHz	
Core i5-6300HQ	45W	6M	Up to 3.20 GHz	
Core i5-6440EQ	45W	6M	Up to 3.40 GHz	Yes
Core i5-6442EQ	45W	6M	Up to 2.70 GHz	

1.5 Mechanical Dimension

1.5.1 Dimensions of ECS-9771

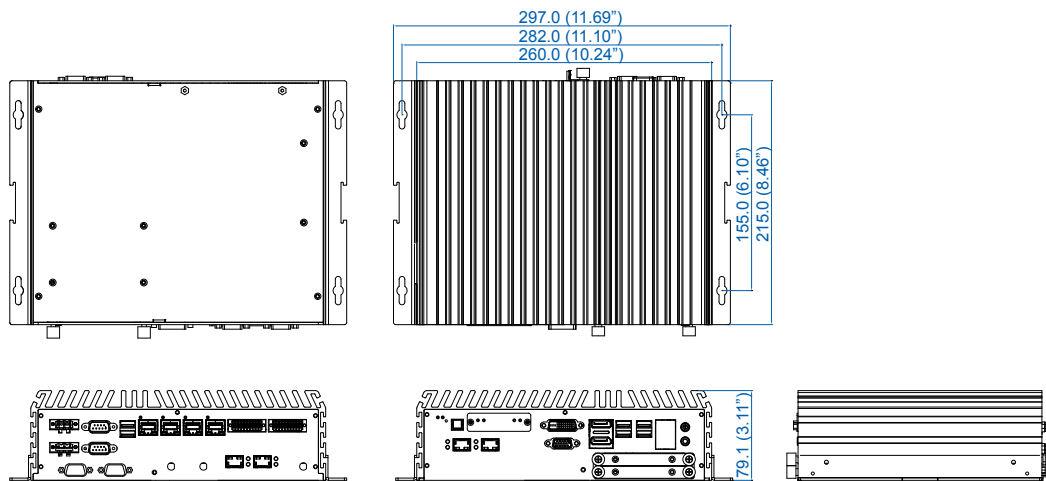

Unit: mm (inch)

2

GETTING TO KNOW YOUR ECS-9771

2.1 Packing List

Item	Description	Qty
1	ECS-9771 10GigE Embedded System (According to the configuration you order, the ECS-9771 series may contain SSD/HDD and DDR4 SO-DIMM. Please verify these items if necessary.)	1
2	ECS-9771 Accessory box, which contains <ul style="list-style-type: none">• Vecow Drivers & Utilities DVD• Wall-mounting bracket• KHS#6-32x6 screw for wall-mounting bracket• M2.5x6 screw for Mini PCIe Slot• Din-Rail-PH-M4x16.5-S Ni• 3-pin pluggable terminal block• 20-pin pluggable terminal block• Foot Pad• F-M3x4 for SSD/HDD screws	1 2 4 4 4 2 2 4 4

2.2 Front Panel I/O & Functions

In Vecow ECS-9771 series family, all I/O connectors are located on the front panel and the rear panel. Most of the general connections to computer device, such as dual 10 GigE SFP+ Fiber LAN, USB, LAN Jack, Audio, VGA, Display, DVI-D and other additional storage, are placed on the front panel.

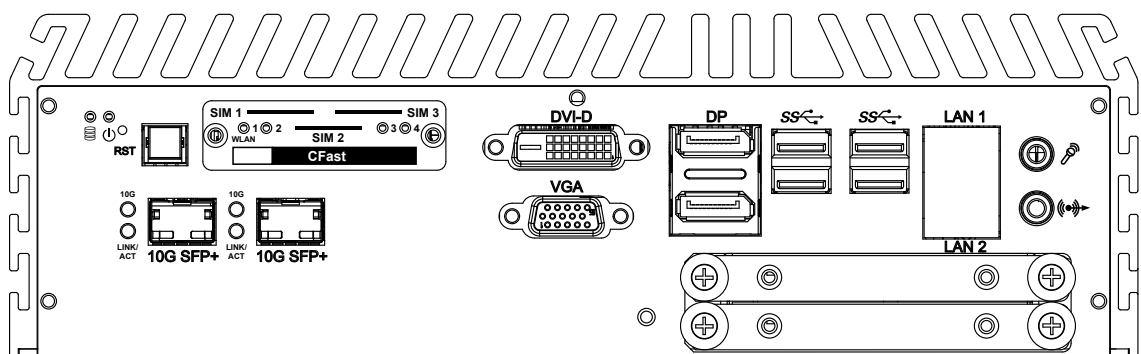

2.2.1 Power Button

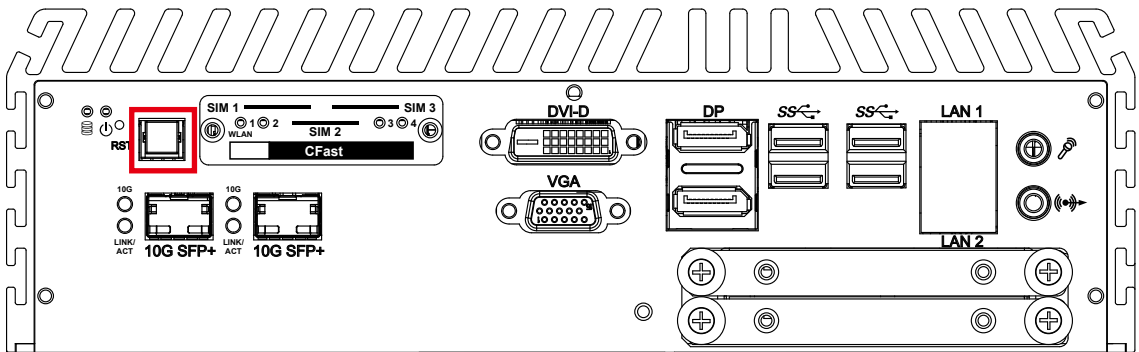

The Power Button is a non-latched switch with dual color LED indications. It indicates power status: S0, S3 and S5. More detail LED indications are listed as follows:

LED Color	Power Status	System Status
Solid Blue	S0	System working
Solid Orange	S3, S5	Suspend to RAM, System off with standby power

To power on ECS-9771, please press the power button and then the blue LED is lightened. To power off the system, you can either command shutdown by OS operation, or just simply press the power button.

If system error, you can just press the power button for 4 seconds to shut down the machine directly. Please do note that a 4-second interval between each 2 power-on/power-off operation is necessary in normal working status. (For example, once turning off ECS-9771, you have to wait for 4 seconds to initiate another power-on operation.)

2.2.2 Reset Tact Switch

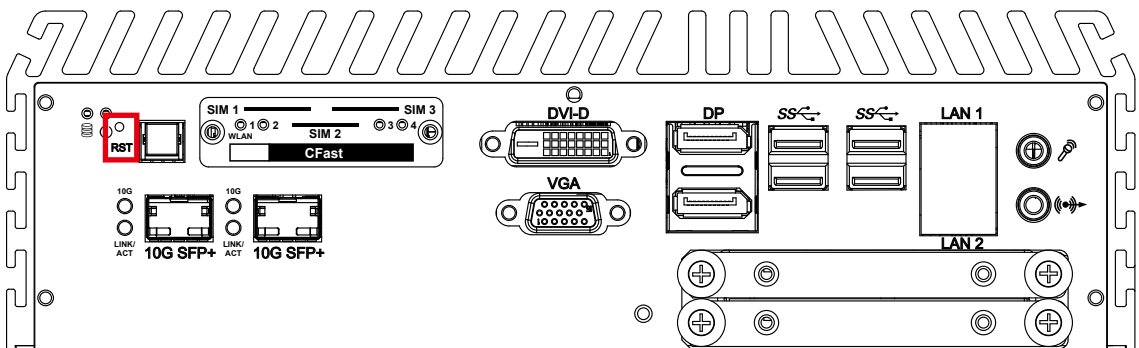

It is a hardware reset switch. Please use this switch to reset ECS-9771 without power off. Press the Reset Switch for a few seconds, and then reset will be enabled.

2.2.3 CFast Card

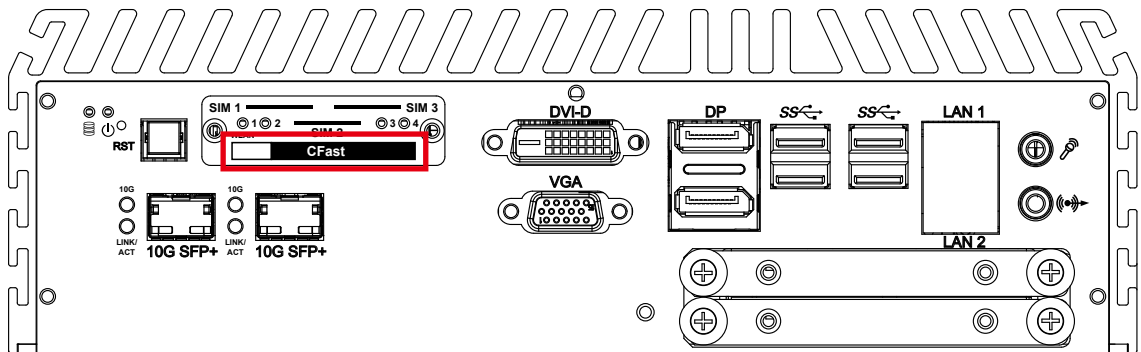

There is a CFast socket on the front panel supporting Type-I/II Compact Flash card. It is implemented by a SATA III Port from CM236 PCH. Be sure to disconnect the power source and unscrew the CFast socket cover before installing a CFast card. The ECS-9771 does not support the CFast hot swap and PnP (Plug and Play) functions. It is necessary to remove power source first before inserting or removing the CFast card.

The pinouts of CFast port are listed as follows:

Pin No.	Description	Pin No.	Description
S1	GND	PC6	NC
S2	SATA_TXP5	PC7	GND
S3	SATA_TXN5	PC8	CFAST_LED
S4	GND	PC9	NC
S5	SATA_RXN5	PC10	NC
S6	SATA_RXP5	PC11	NC
S7	GND	PC12	NC
PC1	GND	PC13	+3.3V
PC2	GND	PC14	+3.3V
PC3	NC	PC15	GND
PC4	NC	PC16	GND
PC5	NC	PC17	NC

2.2.4 PWR and HDD LED Indicator

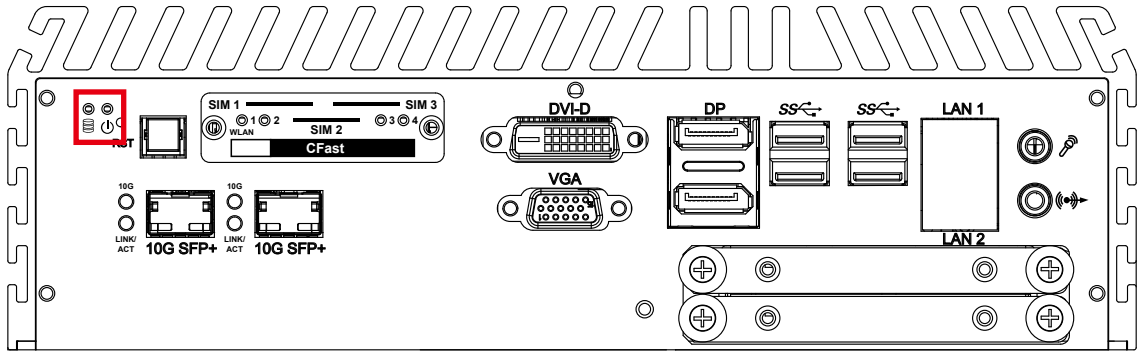

HDD LED/ Yellow : A Hard Disk/ CFAST LED. If the LED is on, it indicates that ECS-9771 storage is functional. If it is off, it indicates that the system's storage is not functional. If it is flashing, it indicates data access activities.

Power LED/ Green: If the LED is solid green, it indicates that ECS-9771 is powered on.

LED Color	Power Status	System Status
Yellow	HDD/ CFAST	<ul style="list-style-type: none"> On/ Off : Storage status, function or not. Twinkling : Data transferring.
Green	Power	System power status (on/ off)

2.2.5 10GigE LAN

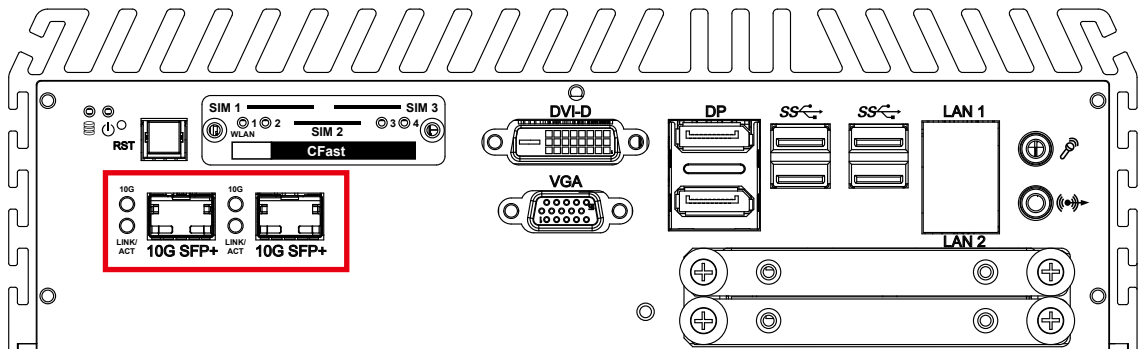

There are dual 10G SFP+ Ethernet connections in the front side. Both are powered by Intel X710-BM2 Ethernet controllers.

Each 10G SFP+ port is supported with LED indicators to present Active/Link/Speed status of the connection. LED indicators as below table:

LED	Status	Color
10G	10G SFP+ Link	Solid Orange
Link/ACT	Link	Solid Green
	Activity	Flash Green

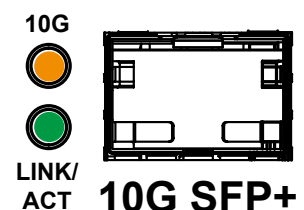

2.2.6 DVI-D Connector

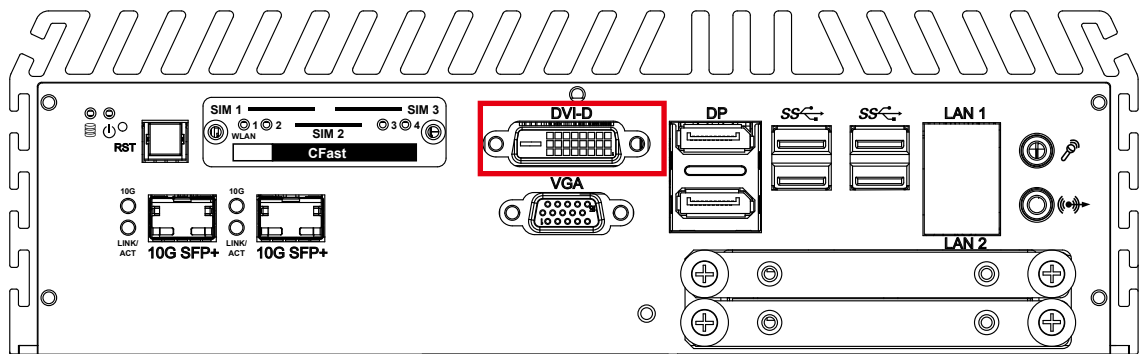

The DVI-D connector on the front panel supports DVI display. This connector can output DVI signal. The DVI output mode supports up to 1920 x 1200 resolution and the DVI is automatically selected according to the display device connected. You will need a DVI-D cable when connecting to a display device.

2.2.7 VGA Connector

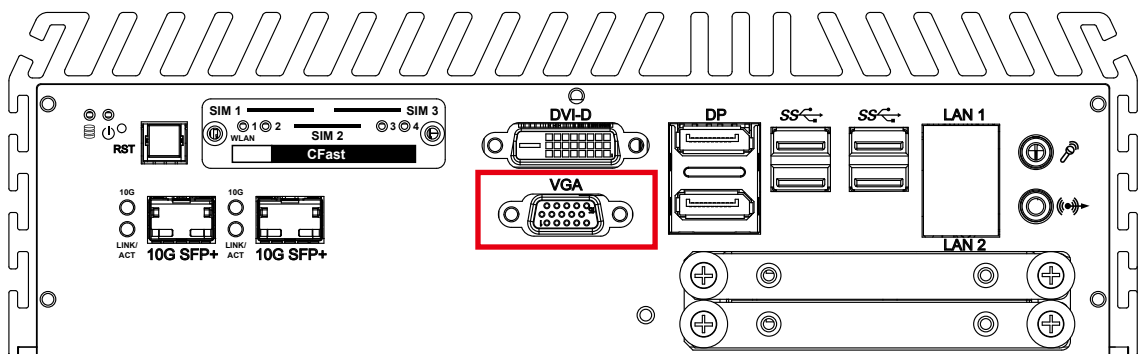

The VGA connector on the front panel supports VGA display. This VGA connector comes from eDP and the VGA output mode supports up to 1920 x 1200 resolution.

Remark: This VGA connector does not support Hot Plug function. If you would like to use the VGA connector, please remain the connection of VGA Display.

2.2.8 DisplayPort

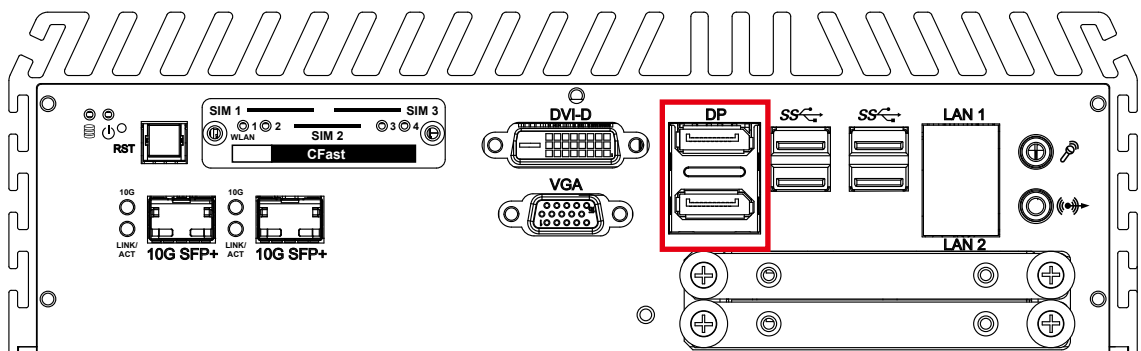

Onboard Display Port supports auxiliary channel dual mode and the connection supports up to 4096 x 2304 resolution at 60 Hz.

Multi-Stream Transport Display Resolutions Table as follows:

Multi-Stream Transport Display	Max. Resolution
One panel Display	4096x2304@60Hz
Two panel Displays concurrently	2880x1800@60Hz
Three panel Displays concurrently	2304x1440@60Hz

2.2.9 3 of 4 Independent Displays

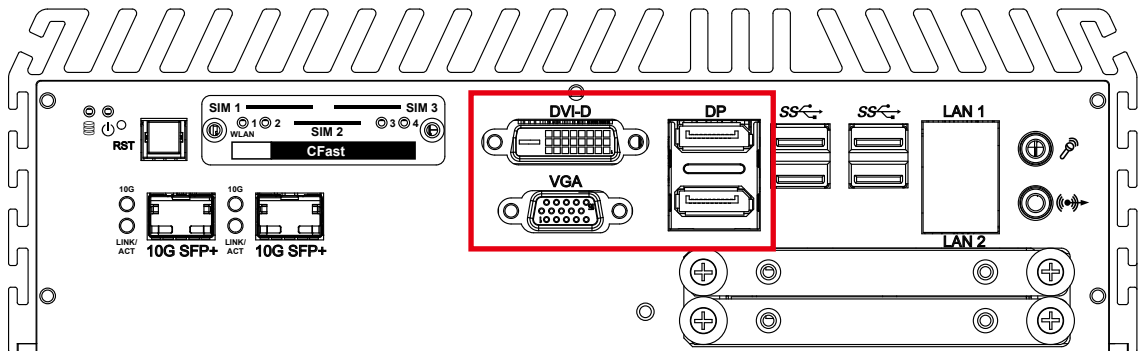

You could have 3 independent displays as your wish from these 4 display ports. Also, you could have two 4K resolution displays, the 2 DisplayPort, from these 4 ports.

2.2.10 USB 3.0

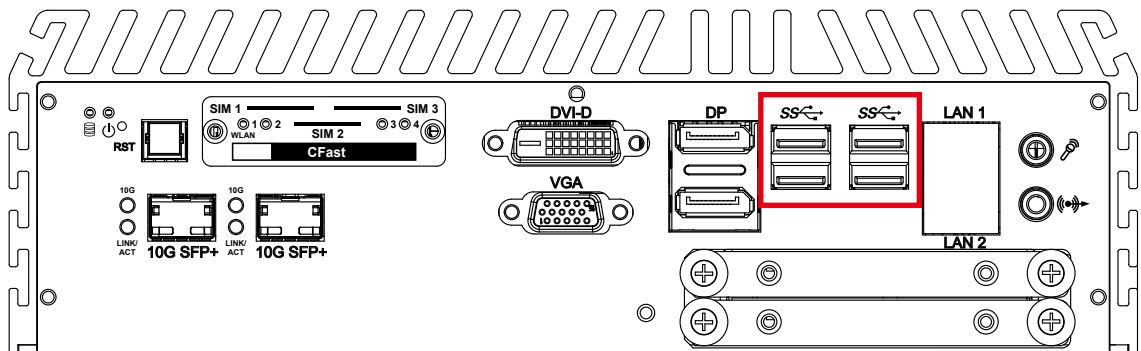

There are 4 USB 3.0 connections available supporting up to 5GB per second data rate in the front side of ECS-9771. It is also compliant with the requirements of Super Speed (SS), High Speed (HS), Full Speed (FS) and Low Speed (LS).

2.2.11 Ethernet Port

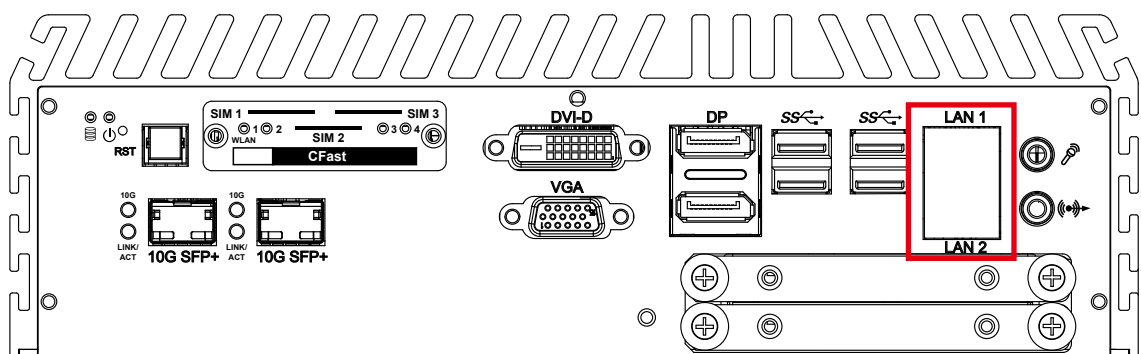

There are dual 8-pin RJ-45 jacks supporting 10/100/1000 Mbps Ethernet connections in the front side. LAN 1 is powered by Intel I219 Ethernet Phy and LAN 2 is powered by Intel I210 Ethernet engine. When both LAN 1 and LAN 2 work in normal status, iAMT 11.0 function is enabled. When using suitable RJ-45 cable, you can connect the system to other computers or to any other devices with Ethernet connection; for example, a hub or a switch. Moreover, both of LAN 1 and LAN 2 support Wake on LAN and Pre-boot functions. The pin-outs of LAN 1 and LAN 2 are listed as follows:

Pin No.	10/ 100Mbps	1000Mbps	Pin No.	10/ 100Mbps	1000Mbps
1	E_TX+	MDI0_P	5	----	MDI2_N
2	E_TX-	MDI0_N	6	E_RX-	MDI1_N
3	E_RX+	MDI1_P	7	----	MDI3_P
4	----	MDI2_P	8	-----	MDI3_N

Each LAN port is supported by standard RJ-45 connector with LED indicators to present Active/Link/Speed status of the connection. The LED indicator on the right bottom corner lightens in solid green when the cable is properly connected to a 100 Mbps Ethernet network, and it lightens in solid orange when the cable is properly connected to a 1000Mbps Ethernet network. The left LED will keep twinkling/off when Ethernet data packets are being transmitted or received.

	10Mbps	100Mbps	1000Mbps
Right Bottom Led	Off	Solid Green	Solid Orange
Left Bottom Led	Flash Orange	Flash Orange	Flash Orange

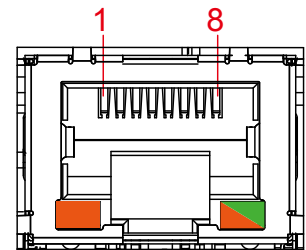

2.2.12 Audio Jack

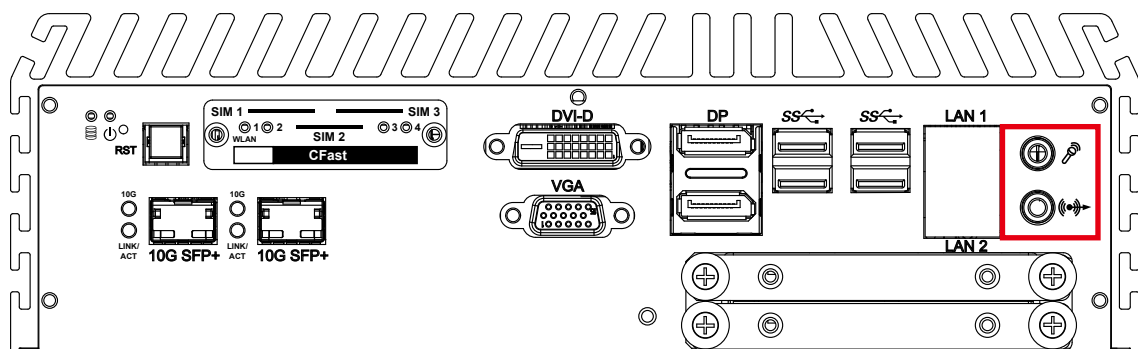

There are 2 audio connectors, Mic-in and Line-out, in the front side of ECS-9771. Onboard Realtek ALC888S-VD audio codec supports 7.1 channel HD audio and fully complies with Intel® High Definition Audio (Azalia) specifications.

To utilize the audio function in Windows platform, you need to install corresponding drivers for both Intel CM236 chipset and Realtek ALC888S-VD codec.

2.2.13 WLAN LED, Mini PCIe, SIM Card Comparison

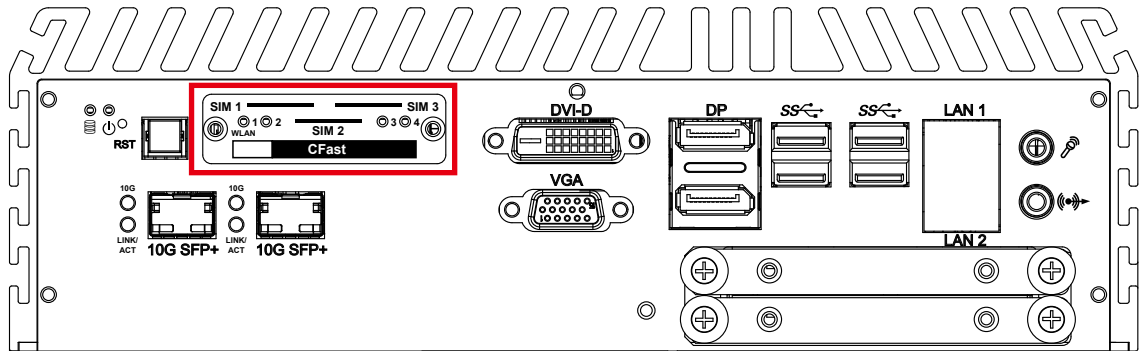

Mini PCIe Slot/SIM Slot/WLAN LED Mapping Table :

Mini PCIe	SIM	LED
Mini PCIe 1 / mSATA (CN12)	SIM 1 (CN13)	1
Mini PCIe 2 / mSATA (CN8)	SIM 2 (CN9)	2
Mini PCIe 3 / mSATA (CN10)	SIM 3 (CN11)	3
Mini PCIe 4 / mSATA (CN6)	SIM 4 (CN7)	4

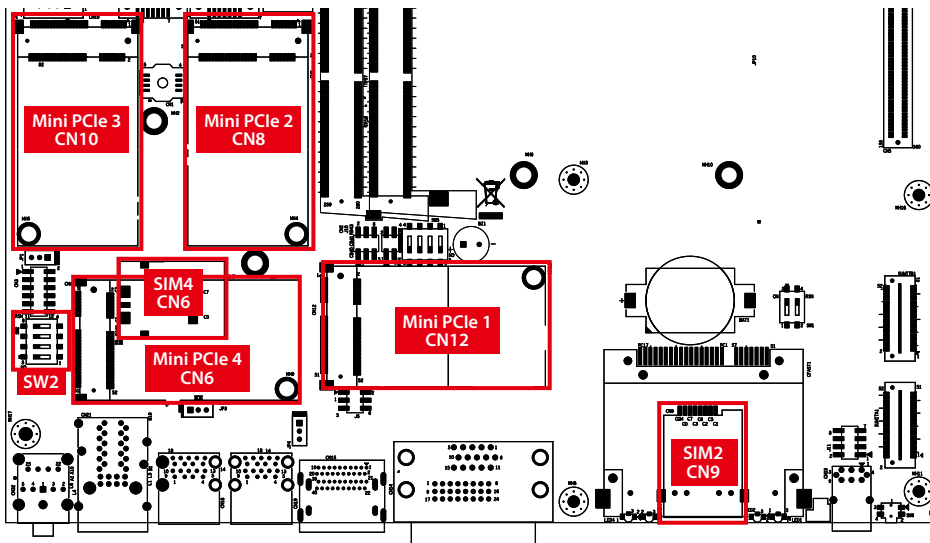

Note:

A. The SIM card sockets do not support hot-plug. Please make sure to unplug the system power before inserting the SIM card(s).

SW2: Mini PCIe 1 to 4; PCIe & mSATA Select SW

DIP Switch		Interface	DIP Switch		Interface
SW2-1	ON	Mini PCIe	SW2-3	ON	Mini PCIe
Mini PCIe 1	OFF	Auto Detection (Default)	Mini PCIe 3	OFF	Auto Detection (Default)
SW2-2	ON	Mini PCIe	SW2-4	ON	Mini PCIe
Mini PCIe 2	OFF	Auto Detection (Default)	Mini PCIe 4	OFF	Auto Detection (Default)

B. Mini PCIe 4 only supports PCIe interface SIM card module.

2.2.14 SSD/HDD Tray

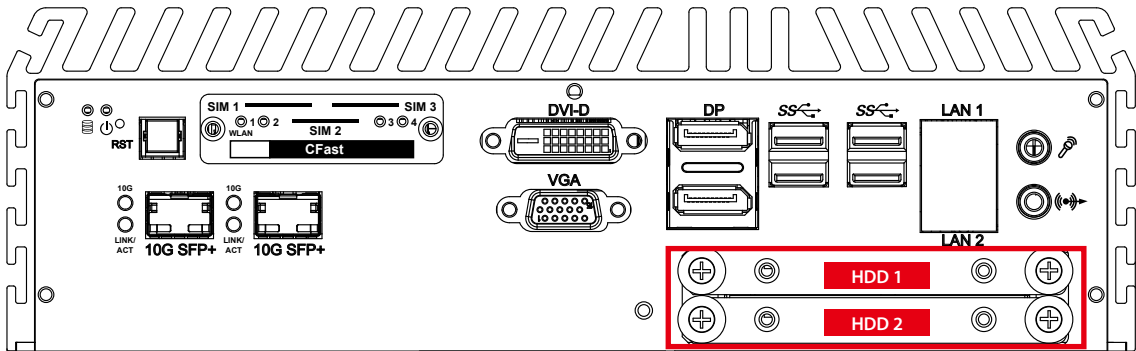

There are 2 front-access 2.5" SSD/HDD trays in the front side of ECS-9771. Just trigger to open the SSD/HDD tray, up to 8TB is available.

HDD Tray	MB Connector	MB Power Connector
HDD 1	SATA1	Power Conn 1
HDD 2	SATA2	Power Conn 1
	SATA3	Power Conn 2
	SATA4 (Remark: By MB BOM Optional, Default no signal link)	Power Conn 2

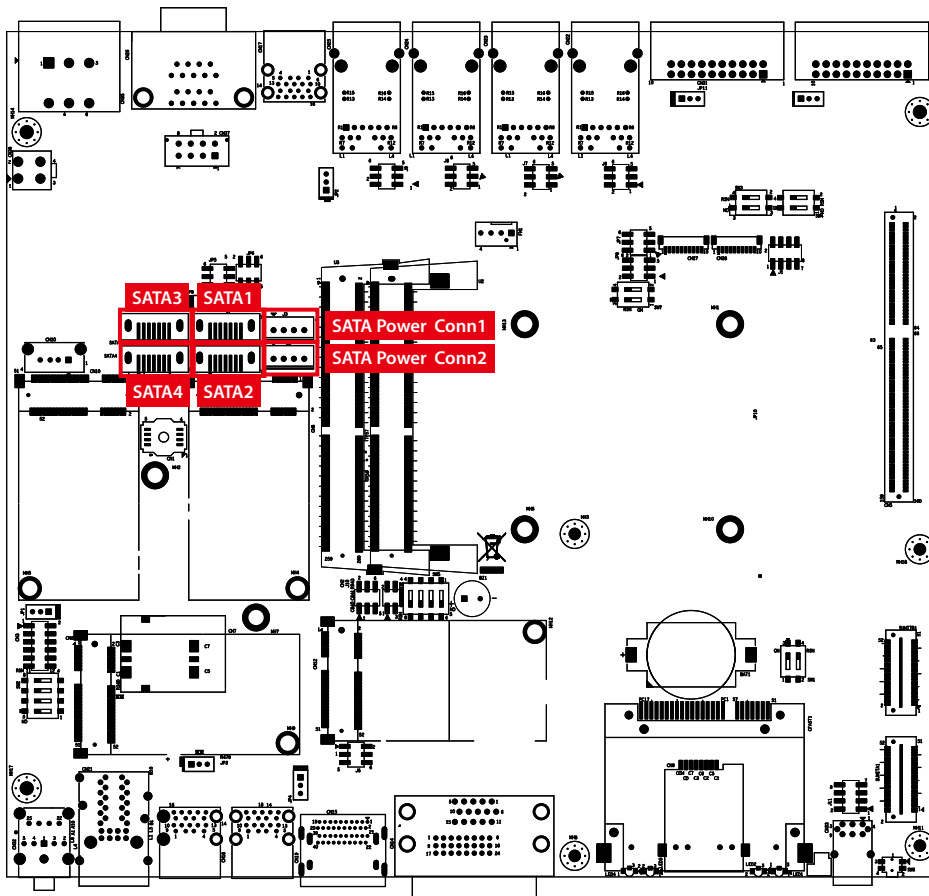

2.3 Rear Panel I/O & Functions

2.3.1 Power Terminal Block

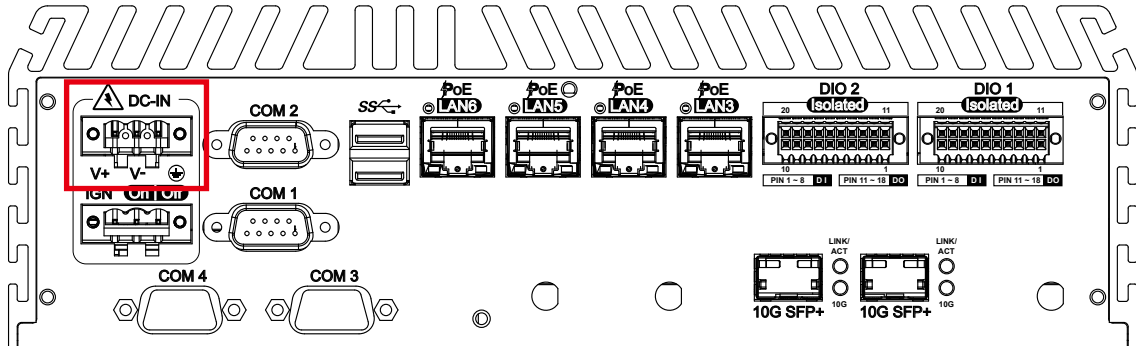

This system supports 6V to 36V DC power input by terminal block in the rear side. In normal power operation, power LED lightens in solid green and supports up to 80V surge protection.

Pin No.	Definition	Pin No.	Definition
1	V+	2	V-
3	Chassis Ground		

2.3.2 Remote Power On/Off Switch & Ignition

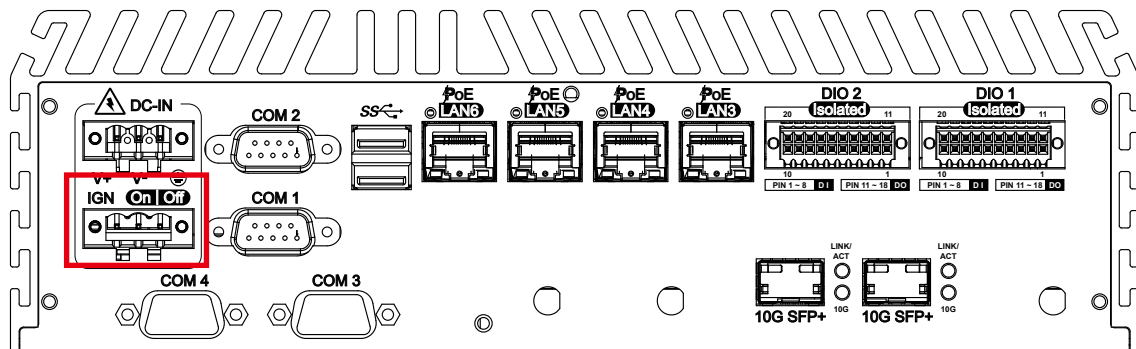

It is a 3-pin power-on or power-off switch through Phoenix Contact terminal block. You could turn on or off the system power by using this contact. This terminal block supports dual function of soft power-on/ power-off (instant off or delay 4 second), and suspend mode.

Pin No.	Definition	Pin No.	Definition
1	Ignition	2	External Power Button V+
3	External Power Button V-		

2.3.3 COM Ports

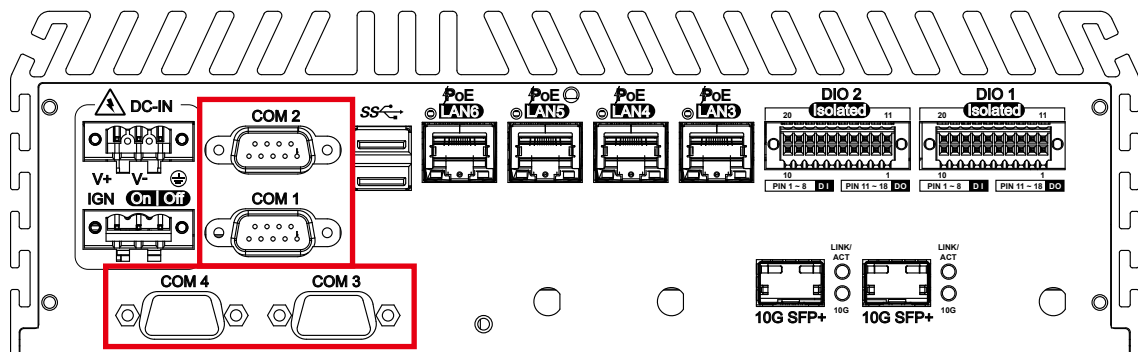

Serial port 1 to 4 (COM 1 to 4) can be configured for RS-232, RS-422, or RS-485 with auto flow control communication. The default definition of COM 1 and COM 2 is RS-232. If you want to change to RS-422 or RS-485, you can find the setting in BIOS.

BIOS Setting	Function
COM 1	RS-232
COM 2	RS-422 (5-wire)
COM 3	RS-422 (9-wire)
COM 4	RS-485
	RS-485 w/z auto-flow control

The pin assignments are listed in the table as below:

Serial Port	Pin No.	RS-232	RS-422 (5-wire)	RS-422 (9-wire)	RS-485 (3-wire)
1 to 4	1	DCD	TXD-	TXD-	DATA-
	2	RXD	TXD+	TXD+	DATA+
	3	TXD	RXD+	RXD+	-----
	4	DTR	RXD-	RXD-	-----
	5	GND	GND	GND	GND
	6	DSR	-----	RTS-	-----
	7	RTS	-----	RTS+	-----
	8	CTS	-----	CTS+	-----
	9	RI	-----	CTS-	-----

COM3 & COM4 MB connector table:

COM Port	MB Connector	COM Port	MB Connector
COM 3	CN27	COM 4	CN28

COM 3 & COM 4 MB connector pin out:

CN	Pin No.	Signal Name
CN27(COM3) CN28(COM4)	1	Chassis GND
	2	GND
	3	RI
	4	DTR
	5	CTS
	6	TXD
	7	RTS
	8	RXD
	9	DSR
	10	DCD

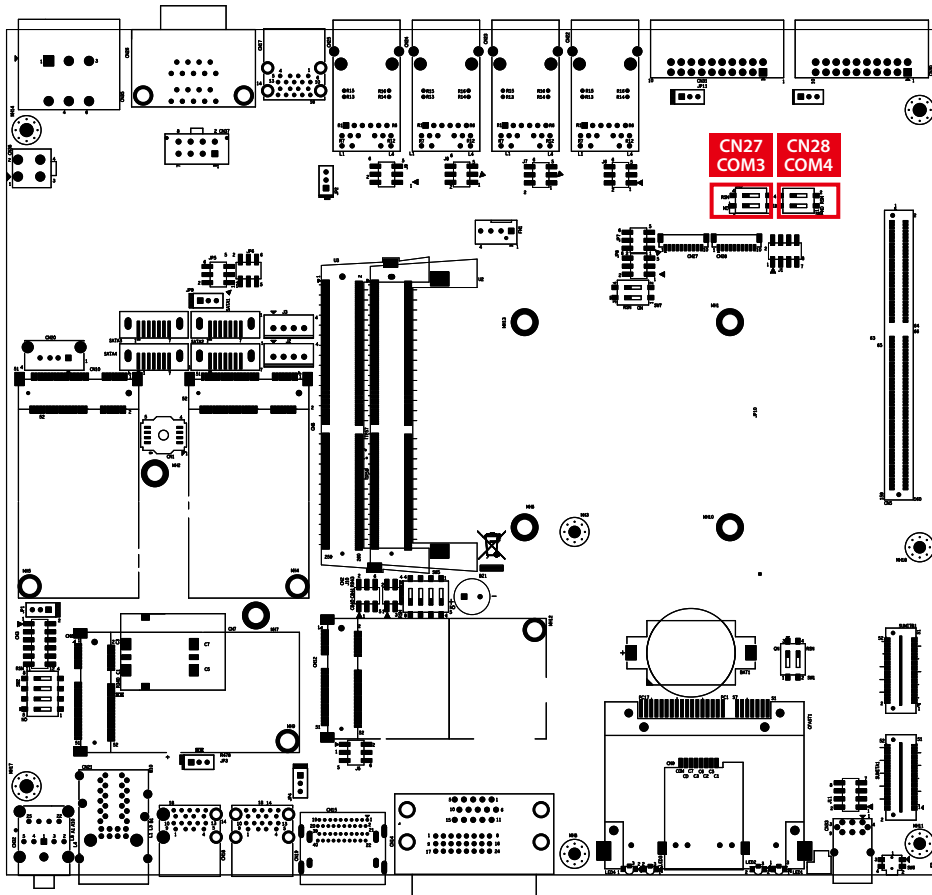

2.3.4 Rear USB 3.0

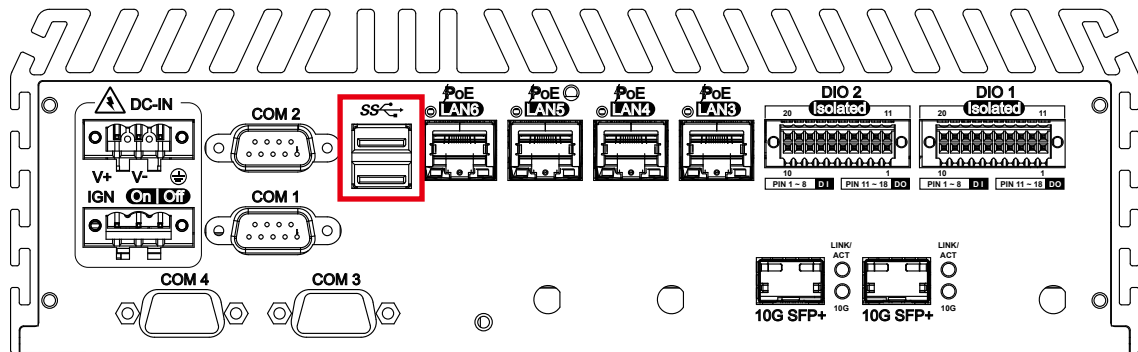

There are 2 USB 3.0 connections available supporting up to 5GB per second data rate in the front side of ECS-9771. It is also compliant with the requirements of Super Speed (SS), High Speed (HS), Full Speed (FS) and Low Speed (LS).

2.3.5 PoE (Power over Ethernet) Ports

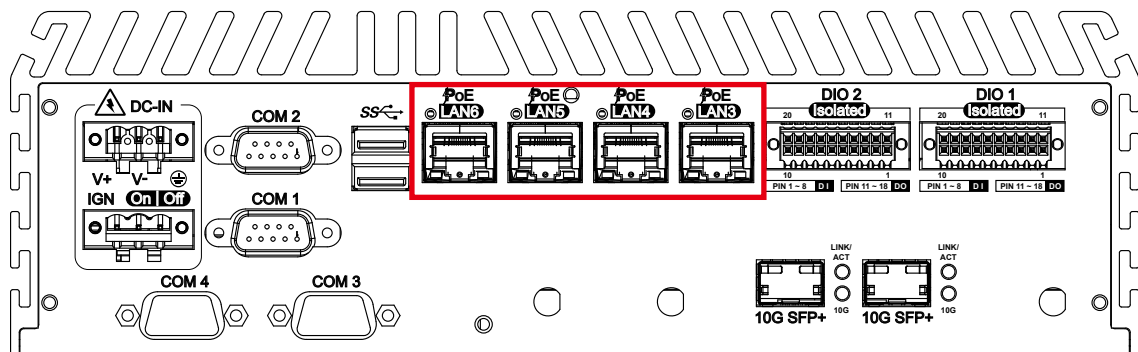

There are quad 8-pin PoE RJ-45 jacks supporting 10/100/1000 Mbps Ethernet connections in the front side powered by Intel I210 Ethernet engine. When both LAN 1 and LAN 2 work in normal status, iAMT 11.0 function is enabled. (Each PoE supports 30.4W)

When using suitable RJ-45 cable, you can connect the system to a computer, or to any other devices with Ethernet connection; for example, a hub or a switch. Moreover, both of LAN 1 and LAN 2 support Wake on LAN and Pre-boot functions. The pin-outs of LAN 1 and LAN 2 are listed as follows:

Pin No.	10/100 Mbps	1000 Mbps	PoE
1	E_TX+	MDI0_P	PoE+
2	E_TX-	MDI0_N	PoE+
3	E_RX+	MDI1_P	PoE-
4	----	MDI2_P	----
5	----	MDI2_N	----
6	E_RX-	MDI1_N	PoE-
7	-----	MDI3_P	----
8	-----	MDI3_N	----

Each LAN port is supported by standard RJ-45 connector with LED indicators to present Active/Link/Speed status of the connection & PoE status LED.

The LED indicator on the right bottom corner lightens in solid green when the cable is properly connected to a 100 Mbps Ethernet network, and it lightens in solid orange when the cable is properly connected to a 1000 Mbps Ethernet network. The left LED will keep twinkling/off when Ethernet data packets are being transmitted/received.

LED Status	10Mbps	100Mbps	1000Mbps
Right Bottom Led	Off	Solid Green	Solid Orange
Left Bottom Led	Flash Orange	Flash Orange	Flash Orange

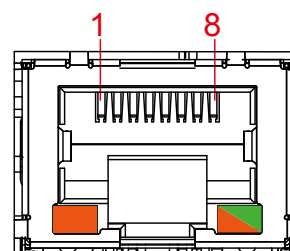

POE LED indicator:

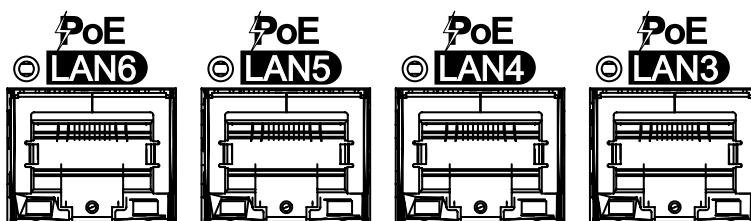

LED Location	LED Color	Status
LAN3	Green	Green Light: PD installed & powered green Off: Non PD
LAN4	Green	Green Light: PD installed & powered green Off: Non PD
LAN5	Green	Green Light: PD installed & powered green Off: Non PD
LAN6	Green	Green Light: PD installed & powered green Off: Non PD

2.3.6 Isolated DIO

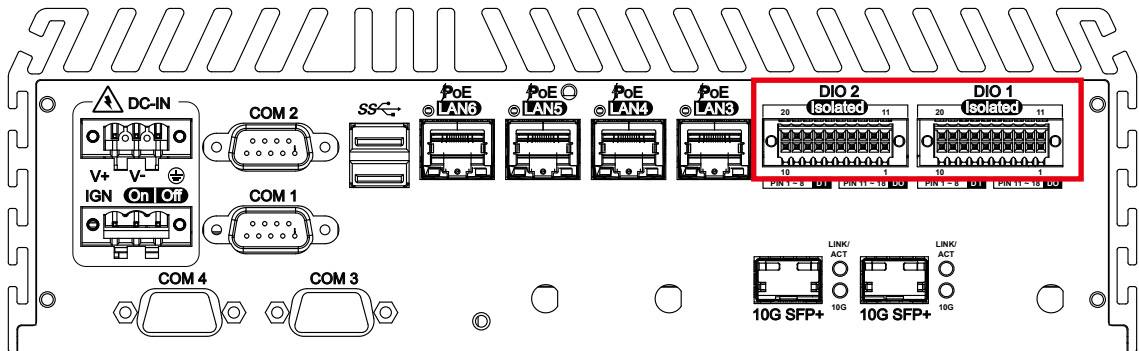

There is a 32-bit (16-bit DI, 16-bit DO) with 2 DIO connectors in the rear side. DI/DIO supports NPN(sink) and PNP(Source) mode, and each DI channel is equipped with a photocoupler for isolated protection. Each DO with isolator chip is configured by a Jumper for each DIO connector.

DO Safety-Related Certifications:

- 4242-VPK Basic Isolation per DIN V VDE V 0884-10 and DIN EN 61010-1
- 3-KVRMS Isolation for 1 minute per UL 1577
- CSA Component Acceptance Notice 5A, IEC 60950-1 and IEC 61010-1 End Equipment Standards
- GB4943.1-2011 CQC Certified

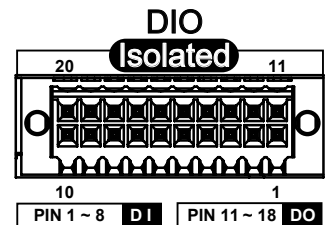

DIO Connectors pin out:

DIO	Pin No.	Definition	Function
DIO1	1	INPUT 0	SIO_GPI80
	2	INPUT 1	SIO_GPI81
	3	INPUT 2	SIO_GPI82
	4	INPUT 3	SIO_GPI83
	5	INPUT 4	SIO_GPI84
	6	INPUT 5	SIO_GPI85
	7	INPUT 6	SIO_GPI86
	8	INPUT 7	SIO_GPI87
	9	DI1_COM	-
	10	DIO1_GND	-
	11	OUTPUT 0	SIO_GPO70
	12	OUTPUT 1	SIO_GPO71
	13	OUTPUT 2	SIO_GPO72
	14	OUTPUT 3	SIO_GPO73
	15	OUTPUT 4	SIO_GPO74
	16	OUTPUT 5	SIO_GPO75
	17	OUTPUT 6	SIO_GPO76
	18	OUTPUT 7	SIO_GPO77
	19	DIO1_GND	-
	20	DIO1_VDC (6~48V Input)	-

DIO	Pin No.	Definition	Function
DIO2	1	INPUT 8	SIO_GPI37
	2	INPUT 9	SIO_GPI50
	3	INPUT 10	SIO_GPI51
	4	INPUT 11	SIO_GPI52
	5	INPUT 12	SIO_GPI56
	6	INPUT 13	SIO_GPI57
	7	INPUT 14	SIO_GPI64
	8	INPUT 15	SIO_GPI65
	9	DI2_COM	-
	10	DIO2_GND	-
	11	OUTPUT 8	SIO_GPO11
	12	OUTPUT 9	SIO_GPO12
	13	OUTPUT 10	SIO_GPO15
	14	OUTPUT 11	SIO_GPO16
	15	OUTPUT 12	SIO_GPO32
	16	OUTPUT 13	SIO_GPO33
	17	OUTPUT 14	SIO_GPO35
	18	OUTPUT 15	SIO_GPO36
	19	DIO2_GND	-
	20	DIO2_VDC (6~48V Input)	-

DI reference circuit:

Sink Mode (NPN)

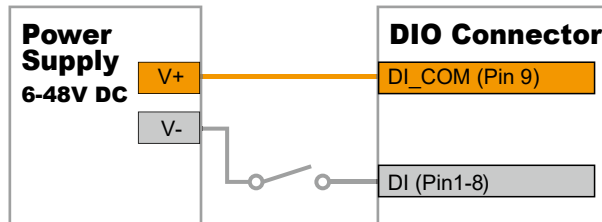

Source Mode (PNP)

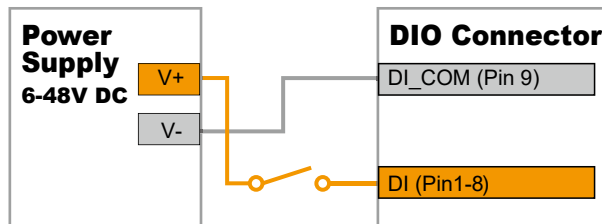

DO Jumper Setting Table:

DIO	Jumper	Setting	Status
DIO1	JP10	1-2 (Default)	NPN (Sink Mode): Max. Input current 100mA / 6 ~48V
DIO1	JP10	2-3	PNP (Source Mode): Max. output current 100mA / 6 ~48V
DIO2	JP11	1-2 (Default)	NPN (Sink Mode): Max. Input current 100mA / 6 ~48V
DIO2	JP11	2-3	PNP (Source Mode): Max. output current 100mA / 6 ~48V

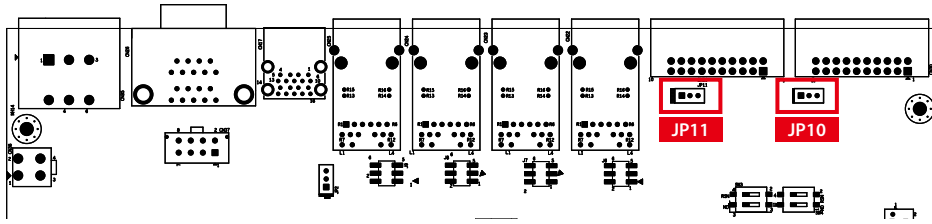

DO reference circuit:

Sink Mode
(NPN, Default)

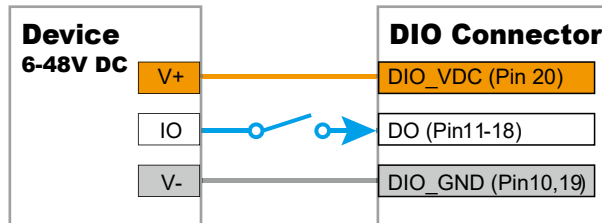

Source Mode
(PNP)

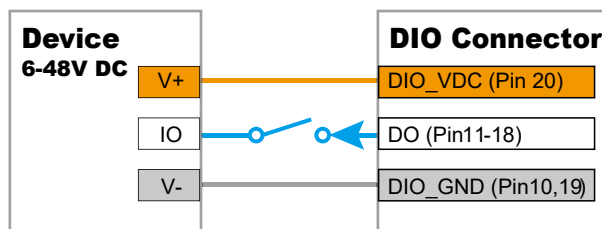

2.3.7 10GigE SFP+ Fiber LAN

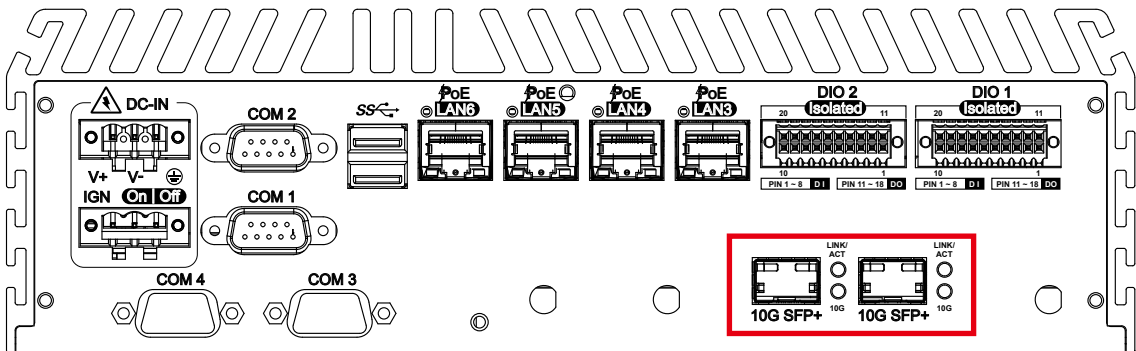

There are dual 10G SFP+ Ethernet connections in the rear side. Both are powered by Intel X710-BM2 Ethernet controllers.

Each 10G SFP+ port is supported with LED indicators to present Active/Link/Speed status of the connection. LED indicators as below table:

LED	Status	Color
10G	10G SFP+ Link	Solid Orange
Link/ACT	Link	Solid Green
	Activity	Flash Green

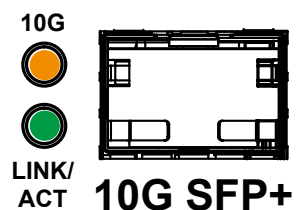

2.4 Main Board Expansion Connectors

2.4.1 Inside View of ECS-9771 Main Board with Connector Location

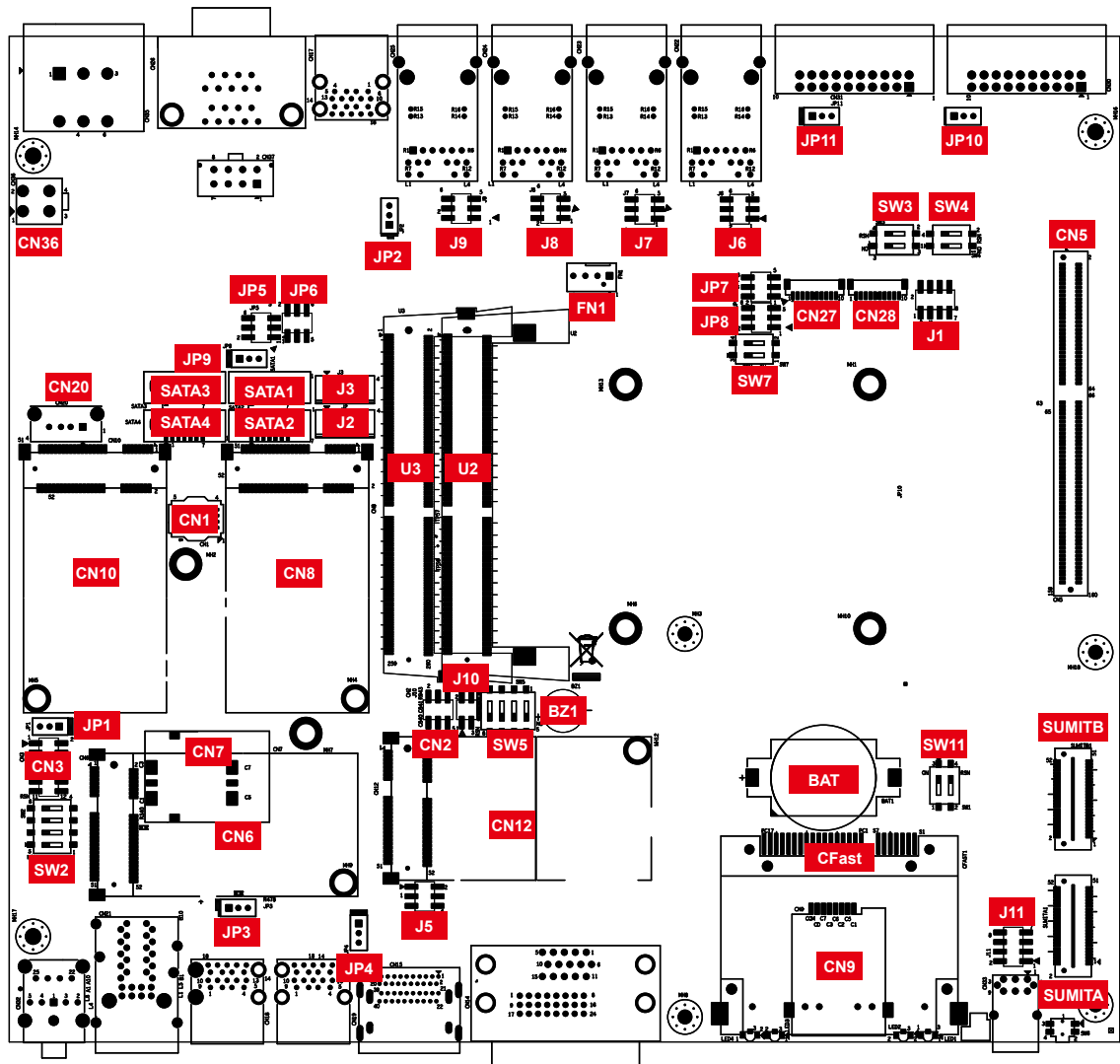

2.4.2 UPS Power Connector

For UPS module optional, we use 4.2mm 2x2p power connector.
This system has a UPS power input connector for optional part UPS module.

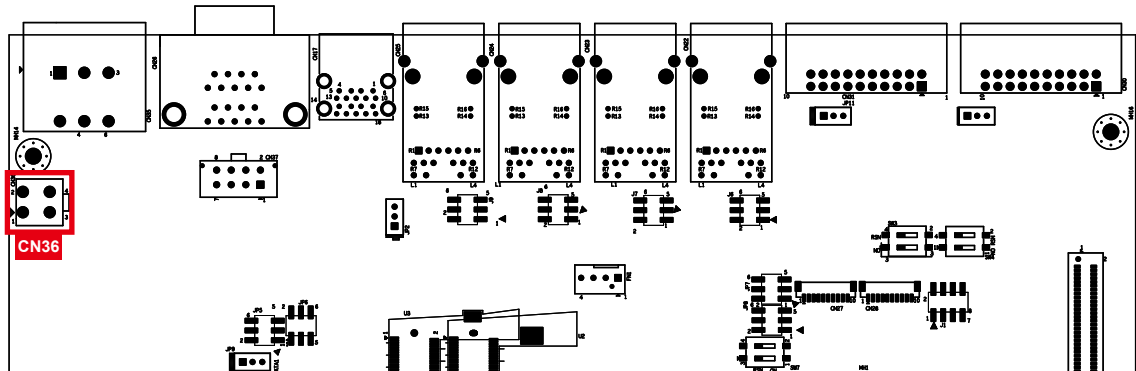

Pin No.	Definition	Pin No.	Definition
1	Ground	2	Ground
3	+VDC_IN (10~36V, Max.8A)	4	+VDC_IN (10~36V, Max.8A)

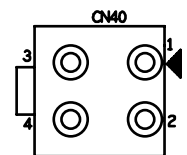

2.4.3 Miscellaneous Pin Header

2.0mm 2x4p header

This pin header can be used as a backup for following functions, such as hard drive LED indicator, reset button, power LED indicator, and power-on/ off button, which already can be accessed by front panel and top panel. The pin-outs of Miscellaneous port are listed in following table:

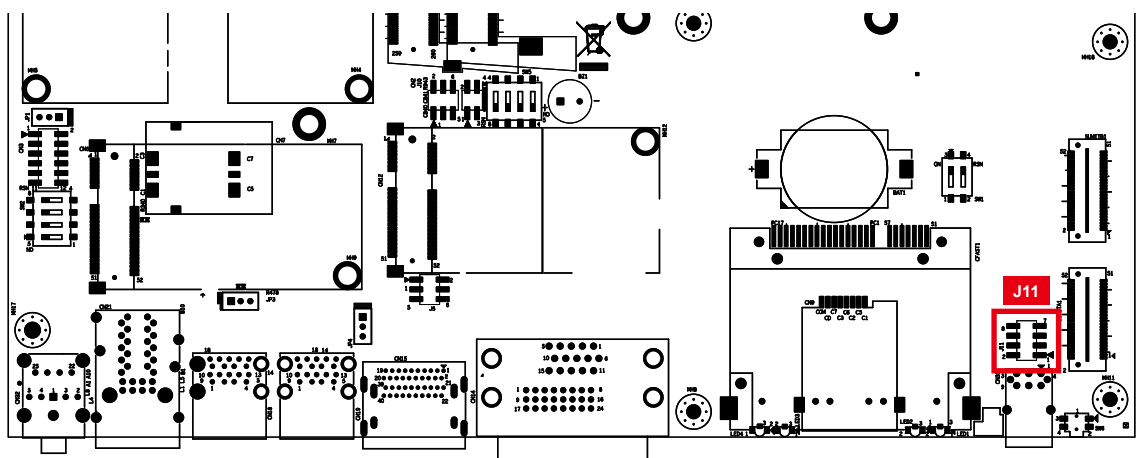

Group	Pin No.	Description
HDD LED	1	HDD_LED_P
	3	HDD_LED_N
RESET BUTTON	5	FP_RST_BTN_N
	7	Ground
POWER LED	2	PWR_LED_P
	4	PWR_LED_N
POWER BUTTON	6	FP_PWR_BTN_IN
	8	Ground

2.4.4 DDR4 Slot

There are 2 DDR4 channel onboard and support DDR4 2133/1866, max 32GB. (Each channel 16GB)

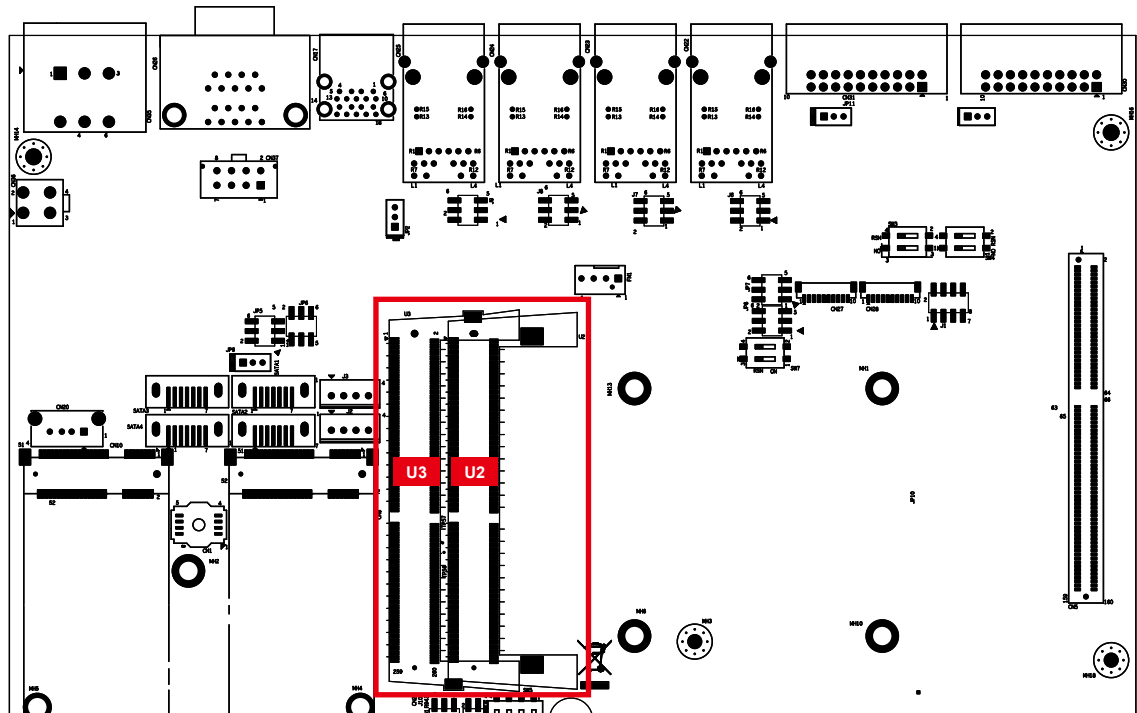

Slot	Description	Slot	Description
Slot1 / U2	DDR4 Channel A	Slot2 / U3	DDR4 Channel B

2.4.5 BIOS Socket

If the BIOS needs to be changed, please contact the Vecow RMA service team.

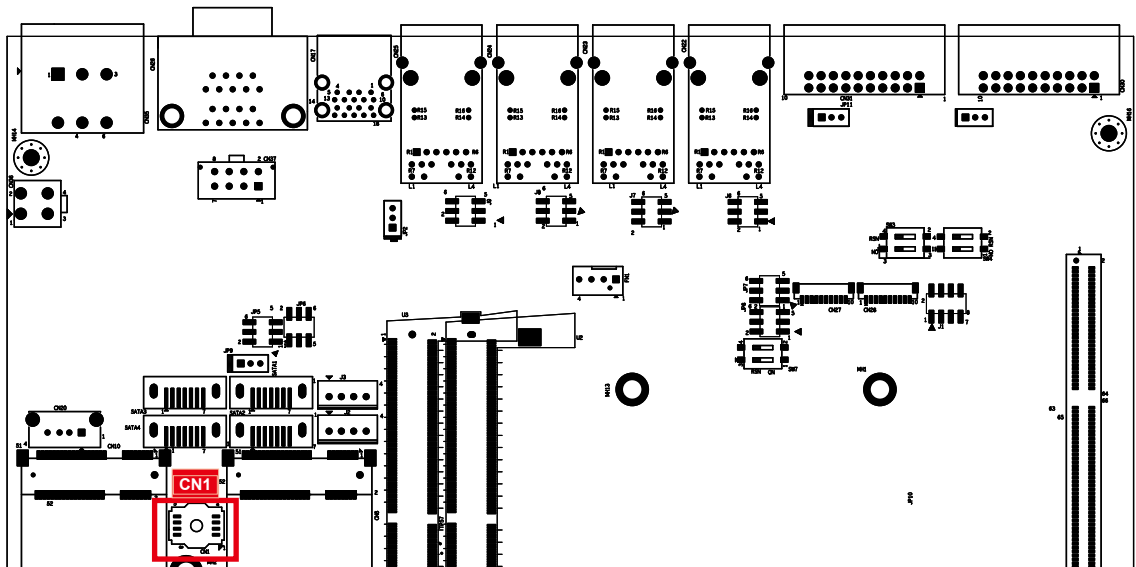

2.4.6 SATA Connector

Standard 7 PIN SATA Connector

There are 4 onboard high performance Serial ATA III. It supports higher storage capacity with less cabling effort and smaller required space. SATA4 is only for BOM option. (Default without function)

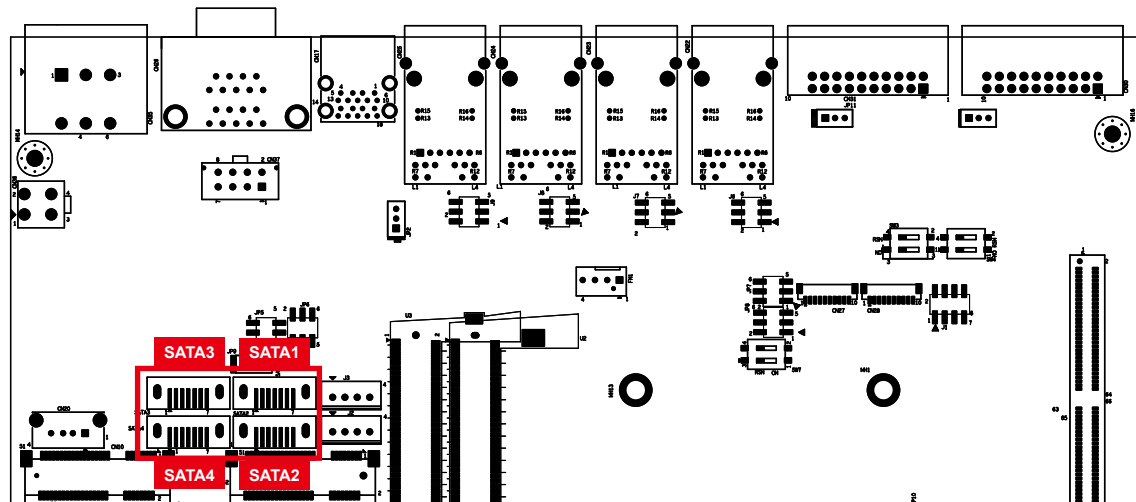

Pin No.	Definition
1	Ground
2	TX DP
3	TX DN
4	Ground

Pin No.	Definition
5	RX DN
6	RX DP
7	Ground

2.4.7 SATA Power Header

Standard, all form factor 1x4p power header

There are 2 HDD power headers on board and each power header supports two 2.5" SATA HDD.

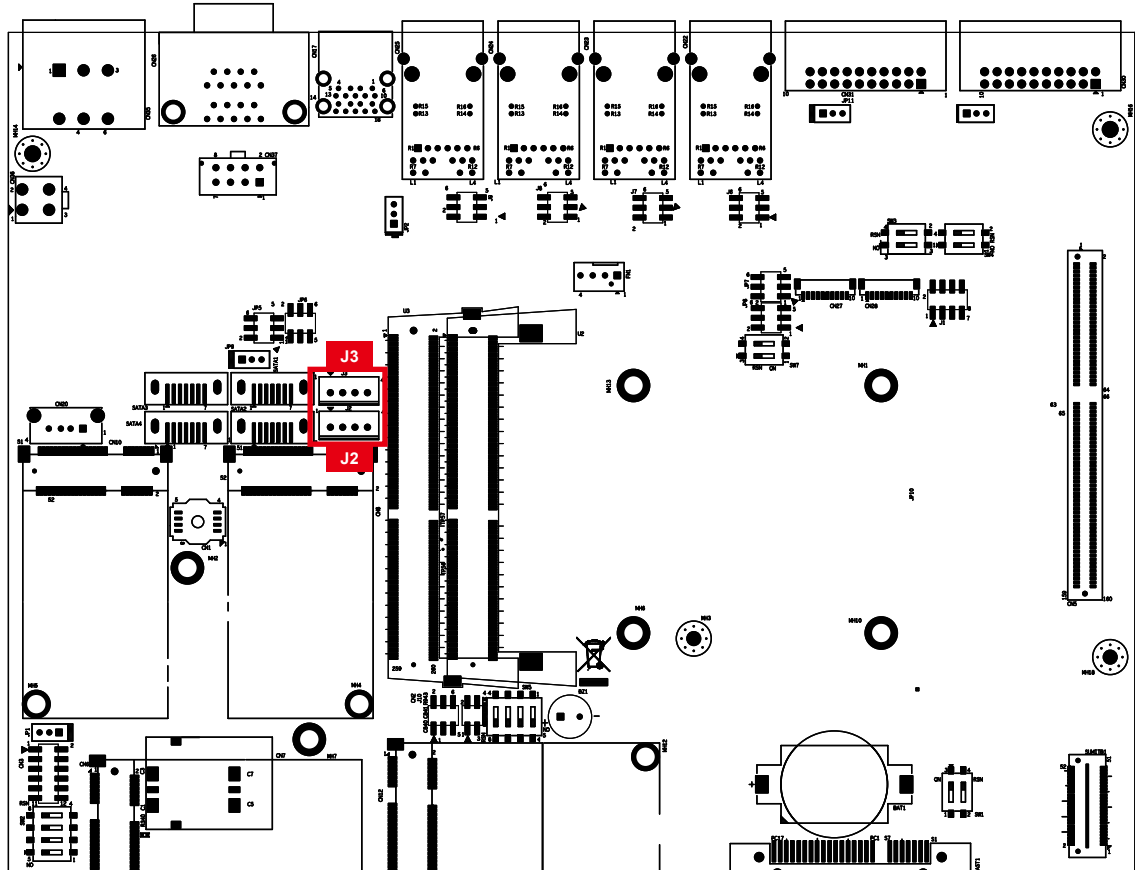

Pin No.	Description	Pin No.	Description
1	+V5 (Max. 4A)	2	Ground
3	Ground	4	+V12 (Max. 1.5A)

2.4.8 Internal USB2.0

Standard Vertical USB 2.0 Connector

ECS-9771 main board provides one expansion USB port using plug-and-play for dongle key or LCD touch Panel. The USB interface supports 480 Mbps transfer rate which comply with high speed USB specification Rev. 2.0.

The USB interface is accessed through one standard USB 2.0 connector. This USB 2.0 does not support wake up function.

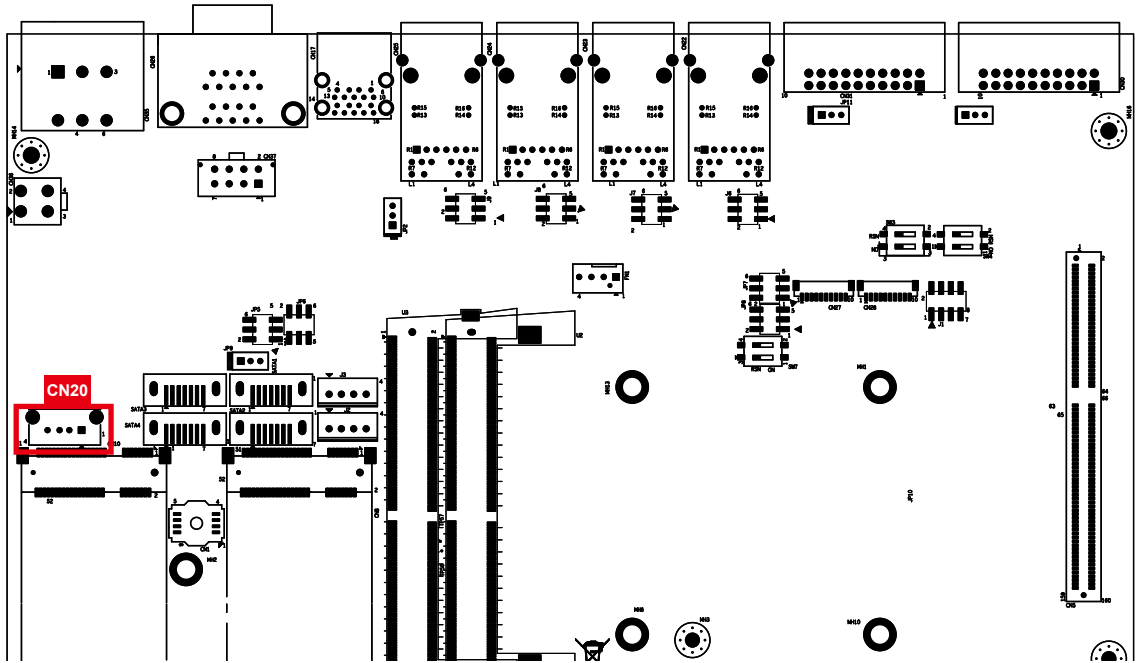

Pin No.	Definition	Pin No.	Definition
1	USB +VCC (+V5/Max. 0.5A)	2	DATA-
3	DATA+	4	Ground

2.4.9 SUMIT A, SUMIT B (Dual 10GigE SFP+ Fiber LAN)

This system has standard SUMIT A and SUMIT B for SUMIT type add on cards. ECS-9771 already had implemented it for 2 10GigE SFP+ Fiber LAN.

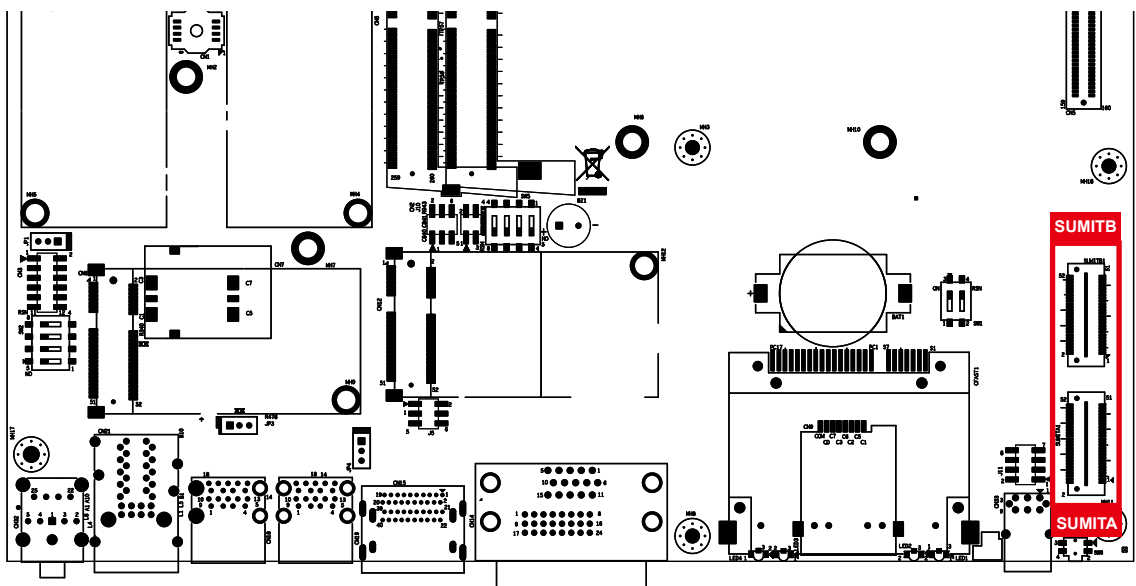

SUMIT A Pin Out:

Pin No.	Function	Pin No.	Function
1	+5V_AUX	2	+12V
3	+3.3V	4	SMB_DATA
5	+3.3V	6	XMB_CLK
7	Reserved	8	Reserved
9	Reserved	10	SPI_MISO
11	USB_OC#	12	SPI_MOSI
13	Reserved	14	SPI_CLK
15	+5V	16	SPI_CS10
17	USB_3+	18	SPI_CS1#
19	USB_3-	20	Reserved
21	+5V	22	LPC_DRQ1#
23	USB_2+	24	LPC_AD0
25	USB_2-	26	LPC_AD1
27	+5V	28	LPC_AD2
29	USB_1+	30	LPC_AD3
31	USB_1-	32	LPC_FRAME#
33	+5V	34	SERIRQ#
35	USB_0+	36	Reserved
37	USB_0-	38	CLK_33MHz
39	GND	40	GND
41	A_PET_P0	42	A_PER_P0
43	A_PET_N0	44	A_PER_N0
45	GND	46	APRSNT#/A_PE_CLKREQ#
47	PERST#	48	A_CLKP
49	WAKE#	50	A_CLKN
51	+5V	52	GND

SUMIT B Pin Out:

Pin No.	Function	Pin No.	Function
1	GND	2	GND
3	B_PET_P0	4	B_PER_P0
5	B_PET_N0	6	B_PER_N0
7	GND	8	GND
9	C_CLKP	10	B_CLKP
11	C_CLKN	12	B_CLKN
13	CPRSNT#/C_PE_CLKREQ#	14	GND
15	C_PET_P0	16	C_PER_P0
17	C_PET_N0	18	C_PER_N0
19	GND	20	GND
21	C_PET_P1	22	C_PER_P1
23	C_PET_N1	24	C_PER_N1
25	GND	26	GND
27	C_PET_P2	28	C_PER_P2
29	C_PET_N2	30	C_PER_N2
31	GND	32	GND
33	C_PET_P3	34	C_PER_P3
35	C_PET_N3	36	C_PER_N3
37	GND	38	GND
39	PERST#	40	WAKE#
41	Reserved	42	Reserved
43	+5V	44	Reserved
45	+5V	46	+3.3V
47	+5V	48	+3.3V
49	+5V	50	+3.3V
51	+5V	52	+5V_AUX

2.4.10 Mini PCIe/mSATA Slot

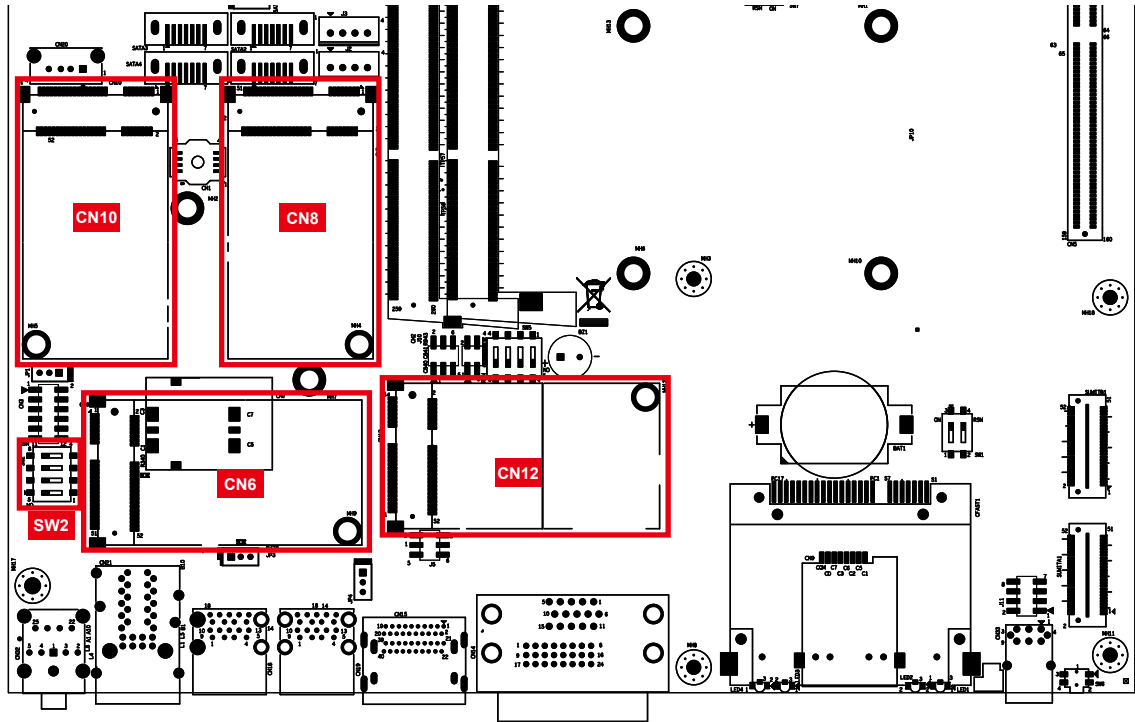

No.	Conn.	SIM	mSATA	USB 2.0	Remark
Mini PCIe 1	CN12	SIM1 (CN13)	SATA4	V	
Mini PCIe 2	CN8	SIM2 (CN9)	SATA5	V	
Mini PCIe 3	CN10	SIM3 (CN11)	SATA6	V	
Mini PCIe 4	CN6	SIM4 (CN7)	SATA7	-	Option with SATA4 HDD Connector SIM Only supports PCIe module

Mini PCIe and mSATA share the same form factor and have similar electrical pinout assignments on their connectors. There's no clear mechanism to distinguish if a mSATA drive or a Mini PCIe device is plugged into the socket until recently that SATA I/O issued an ECN change (ECN #045) to redefine pin-43 on mSATA connector as "no connect" instead of "return current path" (or GND). When mSATA drive is inserted, its pin-43 is "no connect", and the respective pin on the socket is being pulled-up to logic 1. When a Mini PCIe device is inserted, its pin-43 forces the respective pin on the socket to ground, or logic 0.

SW2 is for switching mSATA drive and Mini PCIe device:

DIP Switch		Interface
SW2-1 Mini PCIe 1	ON	Mini PCIe
	OFF	Auto Detection (Default)
SW2-2 Mini PCIe 2	ON	Mini PCIe
	OFF	Auto Detection (Default)
SW2-3 Mini PCIe 3	ON	Mini PCIe
	OFF	Auto Detection (Default)
SW2-4 Mini PCIe 4	ON	Mini PCIe
	OFF	Auto Detection (Default)

Pin Out:

Pin No.	function	Pin No.	function
51	Reserved	52	+3.3Vaux
49	Reserved	50	GND
47	Reserved	48	+1.5V
45	Reserved	46	Reserved
43	GND	44	Reserved
41	+3.3Vaux	42	Reserved
39	+3.3Vaux	40	GND
37	GND	38	USB_D+
35	GND	36	USB_D-
33	PETp0	34	GND
31	PETn0	32	SMB_DATA
29	GND	30	SMB_CLK
27	GND	28	+1.5V
25	PERn0	26	GND
23	PERp0	24	+3.3Vaux
21	GND	22	PERST#
19	Reserved	20	reserved
17	Reserved	18	GND
Mechanical Key			
15	GND	16	UIM_VPP
13	REFCLK+	14	UIM_RESET
11	REFCLK-	12	UIM_CLK
9	GND	10	UIM_DATA
7	CLKREQ#	8	UIM_PWR
5	Reserved	6	1.5V
3	Reserved	4	GND
1	WAKE#	2	3.3Vaux

2.4.11 RTC Battery

ECS-9771 real-time clock is powered by a lithium battery. It is equipped with Panasonic BR2032 190mAh lithium battery. It is recommended that you do not have to get the lithium battery on your own. If the battery needs to be changed, please contact the Vecow RMA service team.

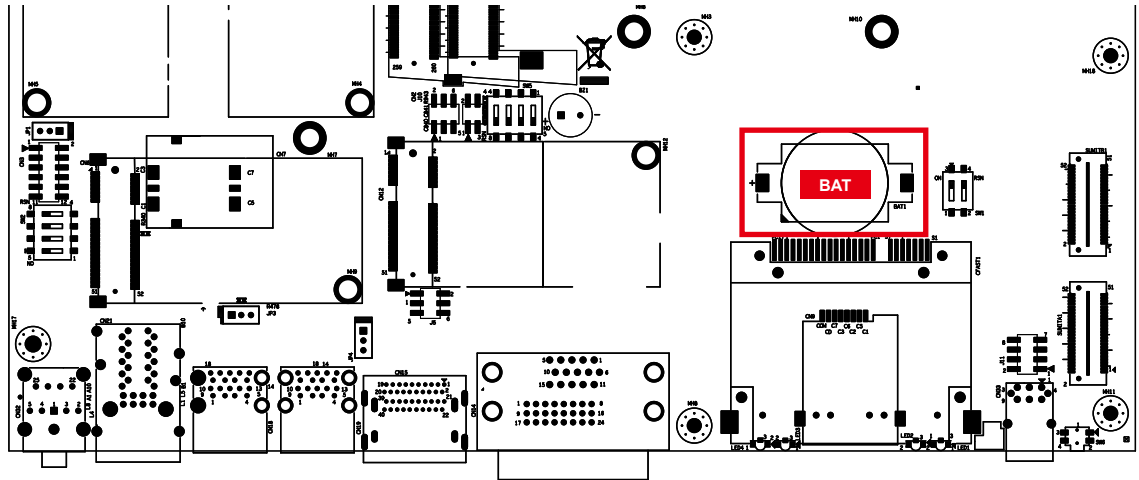

2.4.12 FAN Header

Fan power connector supports for additional thermal requirements. The pin assignments of FAN 1 are shown in the following diagram:

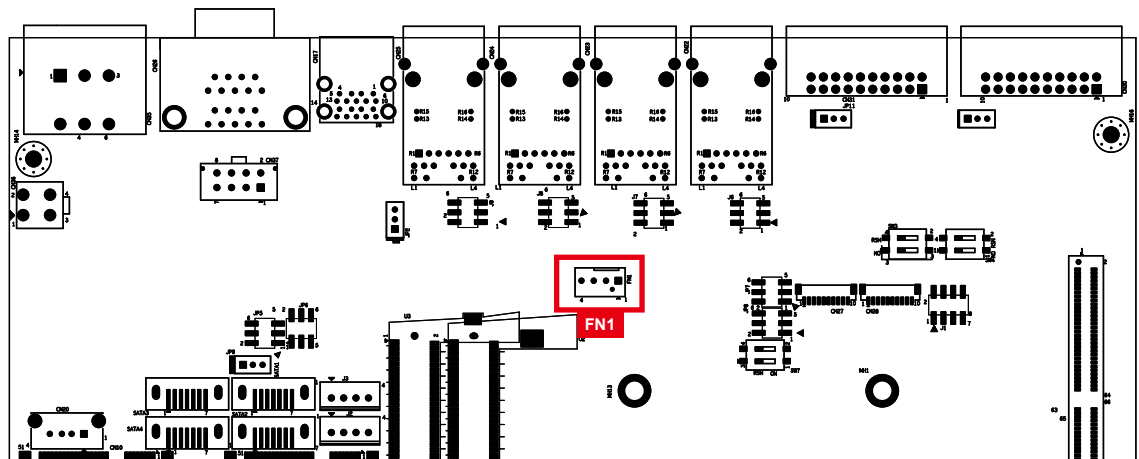

Pin out:

Pin No.	Function	Pin No.	Function
1	GND	2	+12V (1.5A max)
3	Fan speed sensor	4	Fan PWM

2.4.13 LPC Port 80 Header

ECS-9771 provides a LPC Port 80 header for debug card.

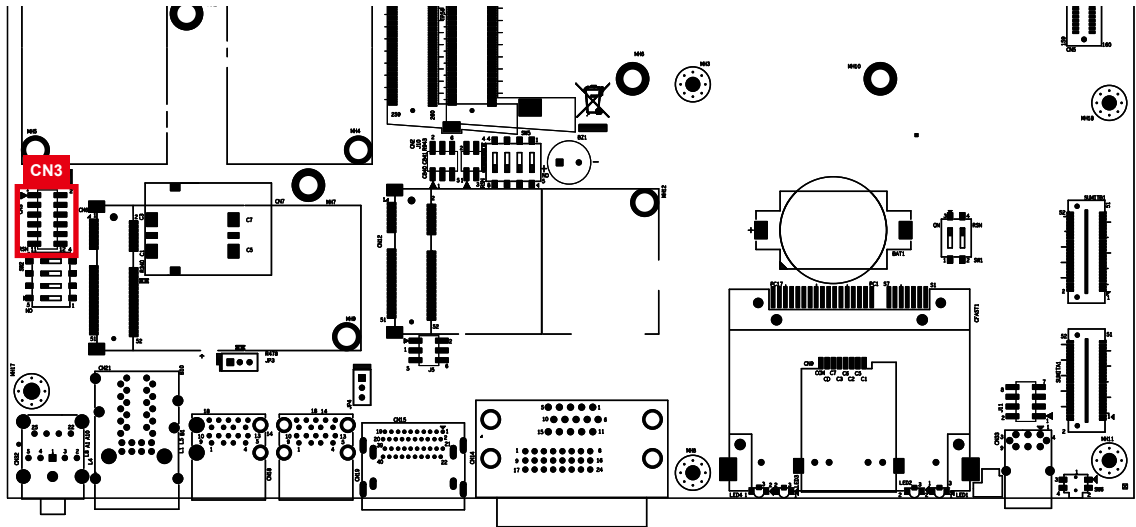

Pin out:

Pin No.	Function	Pin No.	Function
1	SERIRQ	7	LFRAME#
2	+3.3V	8	LAD0
3	LA3	9	N/C
4	RESET#	10	Ground
5	LAD1	11	CLOCK
6	LAD2	12	Ground

2.4.14 LAN IEEE 1588 Header

ECS-9771 provides a LAN header for IEEE 1588.

LAN No.	Controller	Function
Front LAN2	Intel I210	J5
Rear POE LAN3	Intel I210	J6
Rear POE LAN4	Intel I210	J7
Rear POE LAN5	Intel I210	J8
Rear POE LAN6	Intel I210	J9

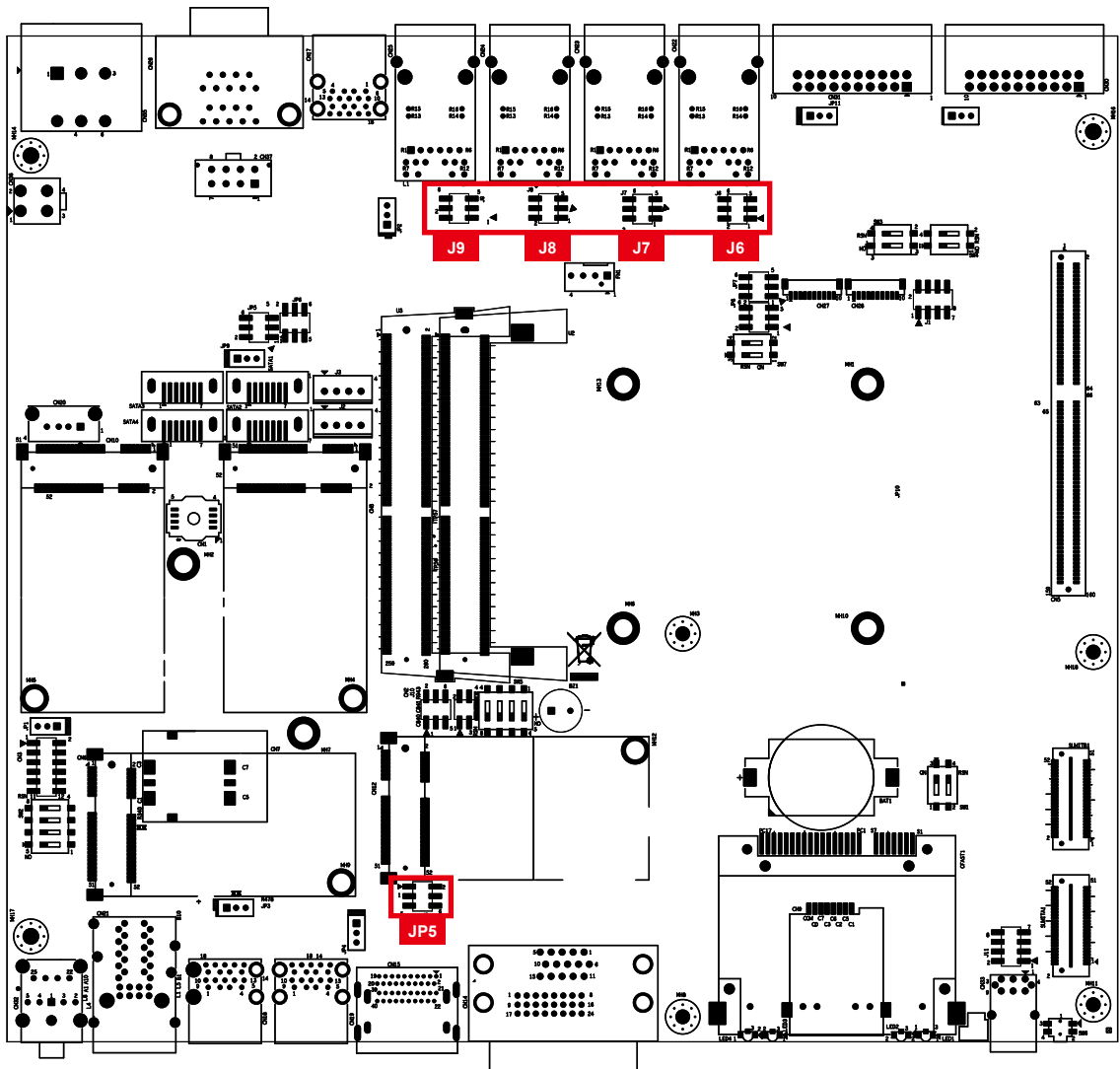

Pin out:

Pin No.	Function	Pin No.	Function
1	SPD0	2	SPD1
3	SPD2	4	SPD3
5	Ground	6	Ground

2.4.15 COM Port Header

ECS-9771 provides 4 COM port headers for internal COM port cables.

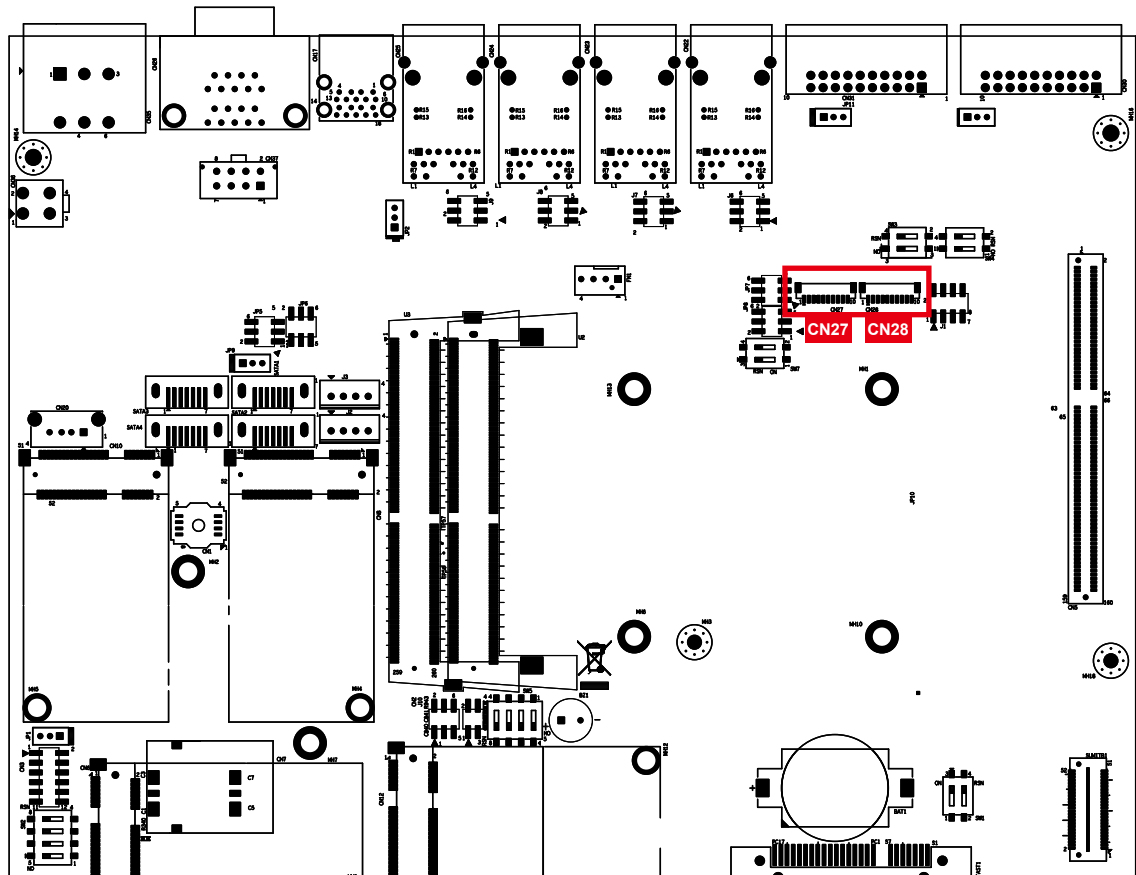

Pin out:

CN27:

Pin No.	Description	Port
1	Ground_Frame	COM3
2	Ground	COM3
3	RI	COM3
4	DTR	COM3
5	CTS	COM3
6	TXD	COM3
7	RTS	COM3
8	RXD	COM3
9	DSR	COM3
10	DCD	COM3

CN28:

Pin No.	Description	Port
1	Ground_Frame	COM4
2	Ground	COM4
3	RI	COM4
4	DTR	COM4
5	CTS	COM4
6	TXD	COM4
7	RTS	COM4
8	RXD	COM4
9	DSR	COM4
10	DCD	COM4

2.5 Main Board Jumper & Deep Switch Settings

2.5.1 Top View of ECS-9771 with Jumper and Deep Switch

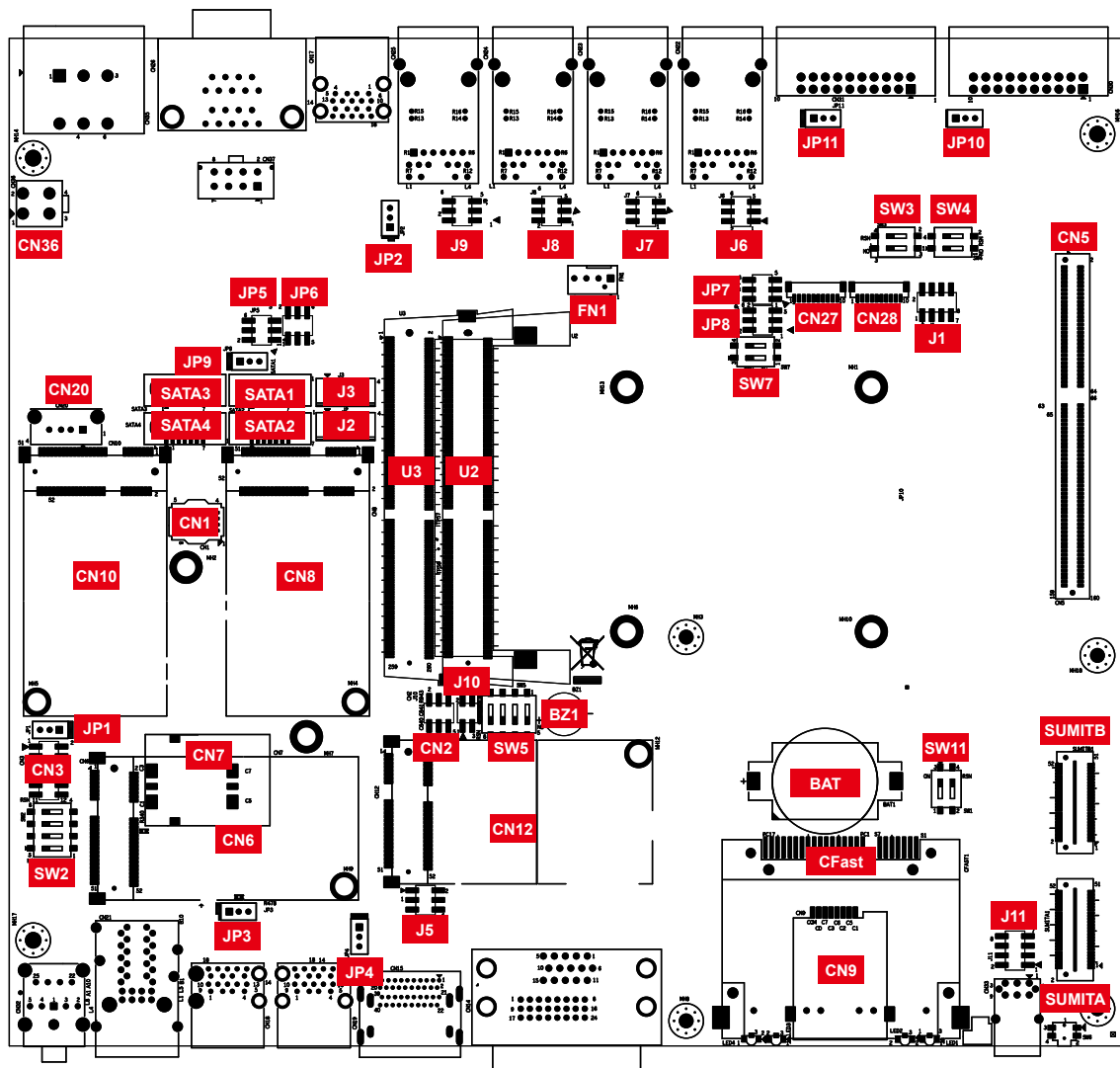

The figure below is the top view of ECS-9771 board, and it shows the location of the jumpers and the switches.

You may configure your card to match the needs of your application by setting jumpers. A jumper is a metal bridge used to close an electric circuit. It consists of two metal pins and a small metal clip (often protected by a plastic cover) that slides over the pins to connect them. To “close” a jumper, please connect the pins with the clip. To “open” a jumper, please remove the clip. Sometimes a jumper will have three pins, labeled 1, 2, and 3. In this case you would connect either pins 1 and 2, or 2 and 3.

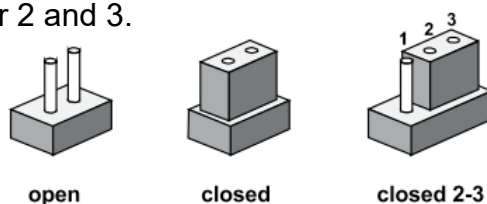

You may configure your card to match the needs of your application by DIP switch as shown below (the deep switch on and off)

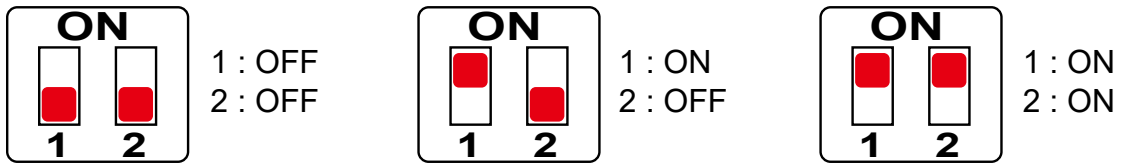

2.5.2 USB Power Jumper

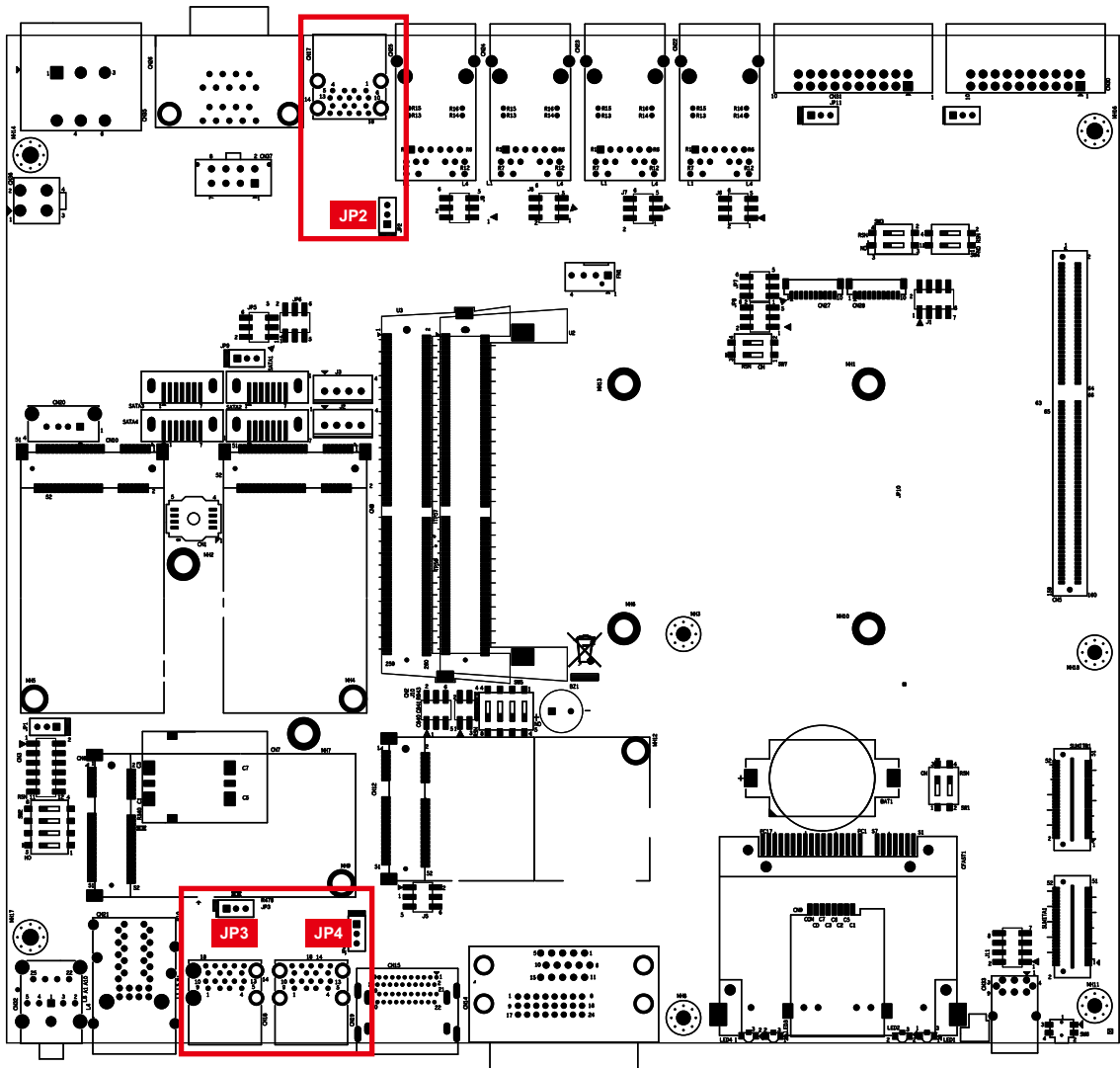

Jumper	Setting	Function	USB Port
JP3	1:2	Non Wake Up support	As front plane, blue mark
JP3	2:3	Supported Wake Up (Default)	As front plane, blue mark
JP4	1:2	Non Wake Up support	As front plane, red mark
JP4	2:3	Supported Wake Up (Default)	As front plane, red mark
JP2	1:2	Non Wake Up support	As rear plane, green mark
JP2	2:3	Supported Wake Up (Default)	As rear plane, green mark

2.5.3 COM Port RI pin Select

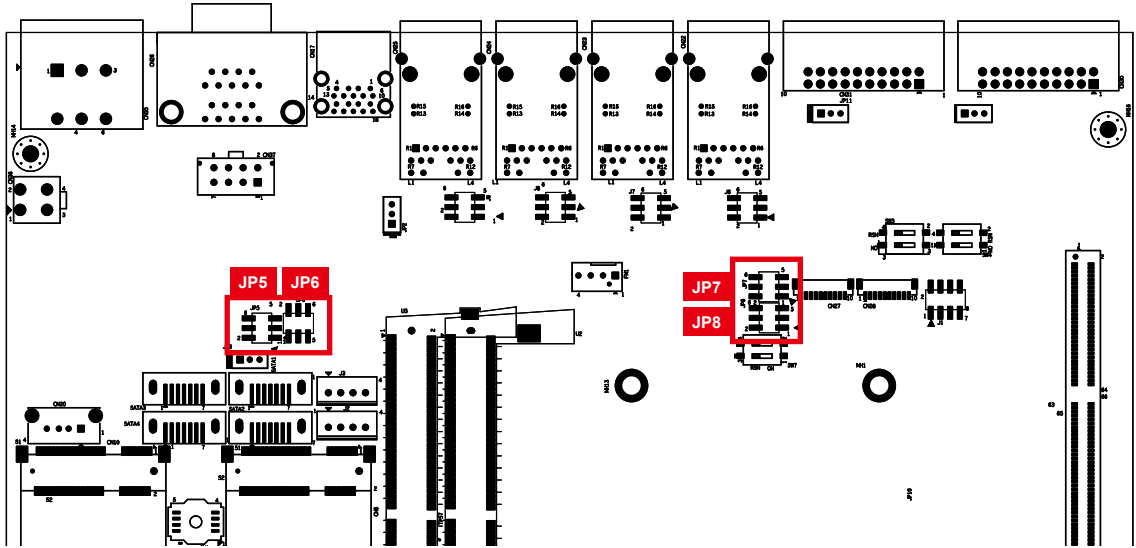

Pin Header	Pin No.	Description
COM1 JP5	1-2	+5V (1A max.)
	3-4	+12V (0.5A max.)
	5-6	RI (Default)
COM2 JP6	1-2	+5V (1A max.)
	3-4	+12V (0.5A max.)
	5-6	RI (Default)
COM3 JP7	1-2	+5V (1A max.)
	3-4	+12V (0.5A max.)
	5-6	RI (Default)
COM4 JP8	1-2	+5V (1A max.)
	3-4	+12V (0.5A max.)
	5-6	RI (Default)

2.5.4 COM Port RS-422/RS-485 Receiver Terminator

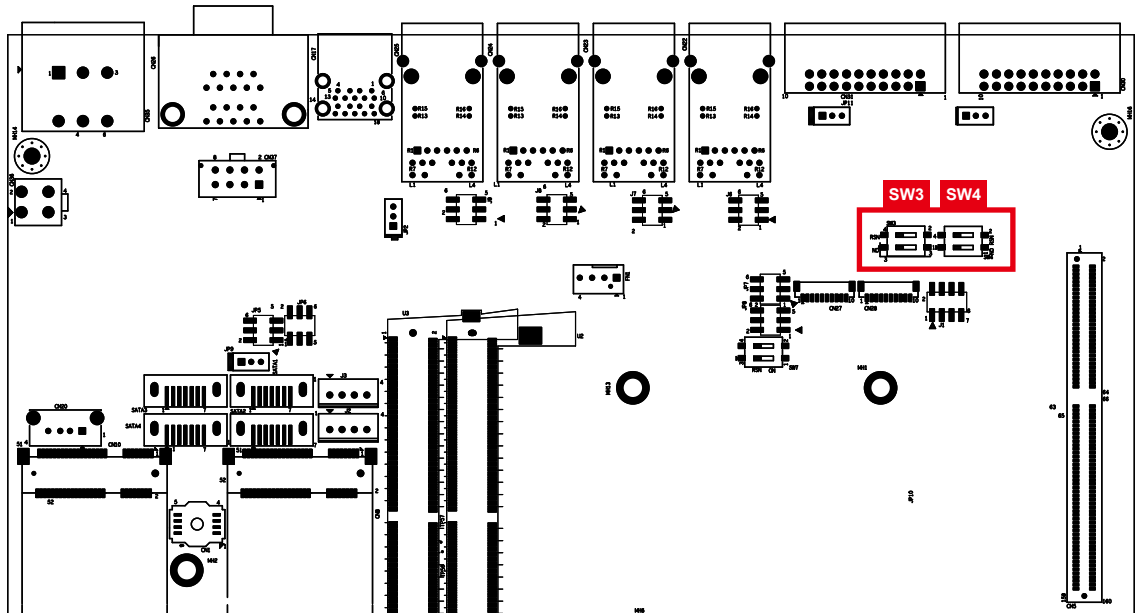

COM / DIP Switch	ON / OFF	COM RS-422/485 Receiver Terminator
COM1 / SW3-1	ON	*Enable
	OFF	Disable

COM / DIP Switch	ON / OFF	COM RS-422/485 Receiver Terminator
COM2 / SW3-2	ON	*Enable
	OFF	Disable

COM / DIP Switch	ON / OFF	COM RS-422/485 Receiver Terminator
COM3 / SW4-1	ON	*Enable
	OFF	Disable

COM / DIP Switch	ON / OFF	COM RS-422/485 Receiver Terminator
COM4 / SW4-2	ON	*Enable
	OFF	Disable

2.5.5 PoE Power ON Select

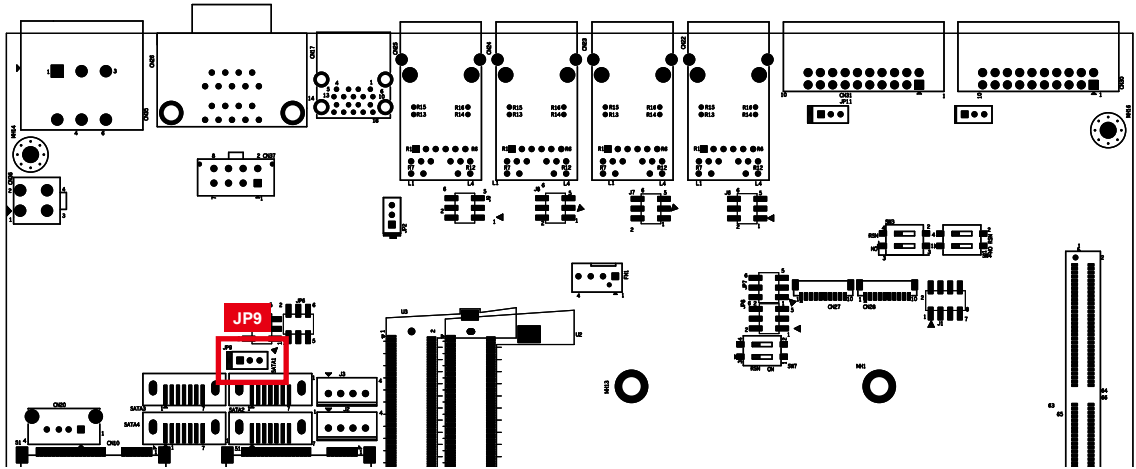

Jumper	Setting	Function
JP9	1:2	PoE power on at standby power ready
JP9	2:3	PoE power on after system power on (Default)

2.5.6 Clear CMOS/ME Switch

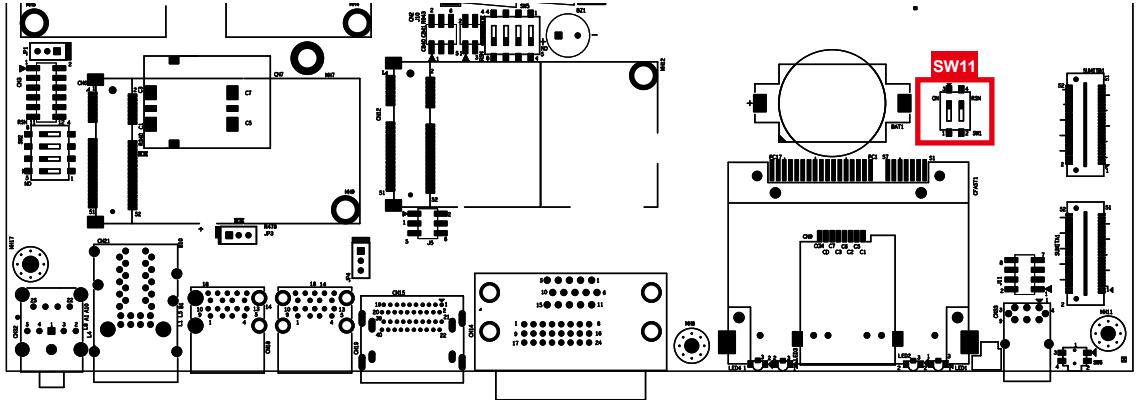

Function	DIP Switch	Description
	SW 1-1	
CMOS Clear Setting	ON	Clear CMOS
	OFF	*Normal

Function	DIP Switch	Description
	SW 1-2	
ME Clear Setting	ON	Clear ME
	OFF	*Normal

2.6 Ignition Control







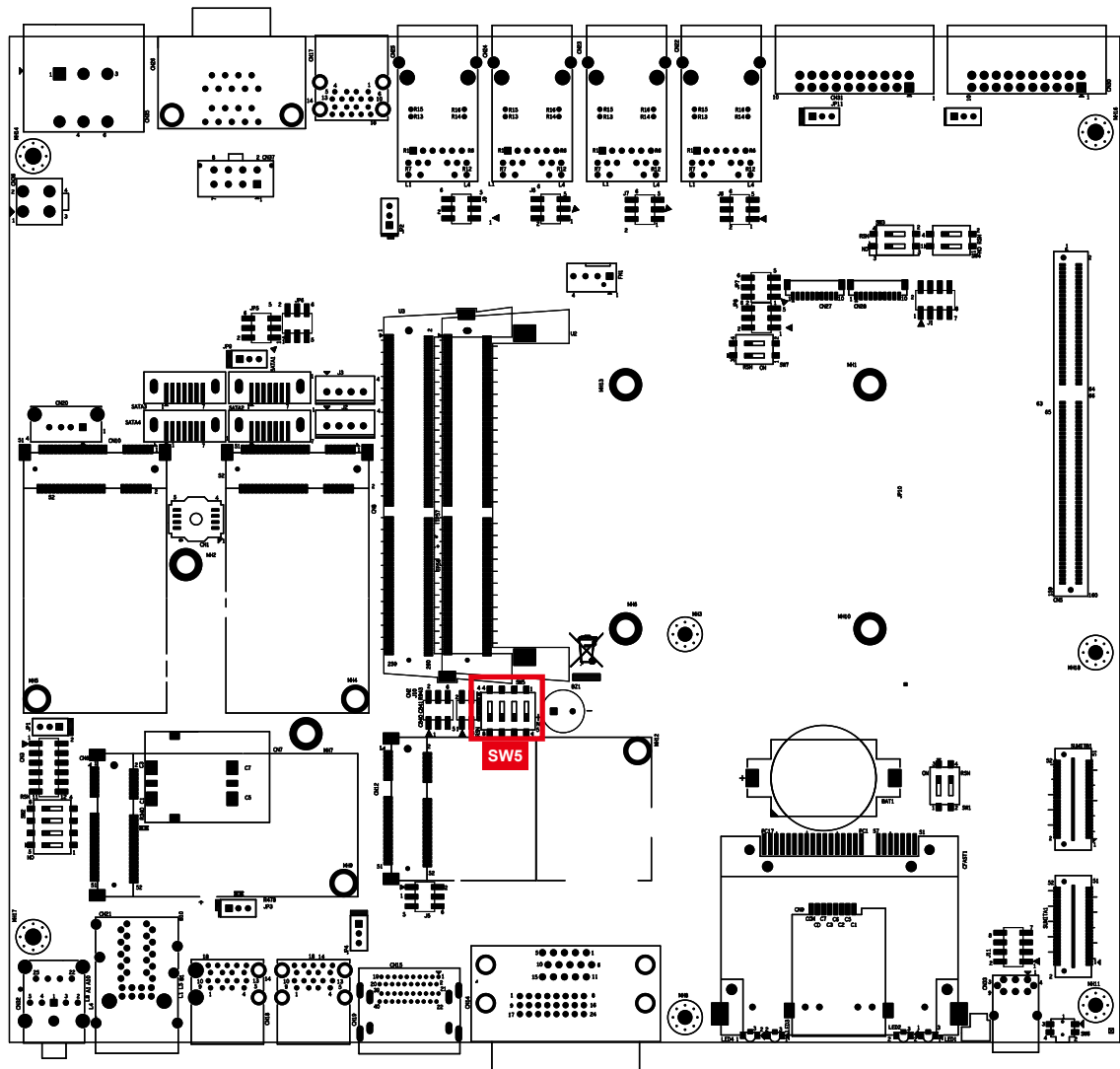



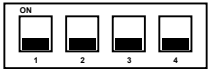



ECS-9771 series provides ignition power control feature for in-vehicle applications. The built-in MCU monitors the ignition signal and turns on/off the system according to pre-defined on/off delay periods.

2.6.1 Adjust Ignition Control Modes

ECS-9771 series provides 16 modes of different power on/off delay periods adjustable via SW5 switch. The default rotary switch is set to 0 in ATX/AT power mode.

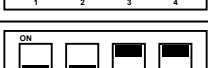

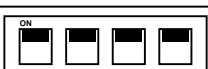
The modes are listed in the following table:

Item	Power on delay	Power off delay	Switch Position
0	ATX mode		
1	No delay	No delay	
2	No delay	5 seconds	
3	No delay	10 seconds	
4	No delay	20 seconds	
5	5 seconds	30 seconds	
6	5 seconds	60 seconds	
7	5 seconds	90 seconds	
8	5 seconds	30 minutes	
9	5 seconds	1 hour	
A	10 seconds	2 hours	
B	10 seconds	4 hours	
C	10 seconds	6 hours	
D	10 seconds	8 hours	
E	10 seconds	12 hours	
F	10 seconds	24 hours	

2.6.2 Ignition Control Wiring

To activate ignition control, you need to provide IGN signal via the 3-pin pluggable terminal block located in the back panel. Please find below the general wiring configuration.



Pin No.	Definition
1	Ignition (IGN)
2	External Power S/W +
3	External Power S/W +

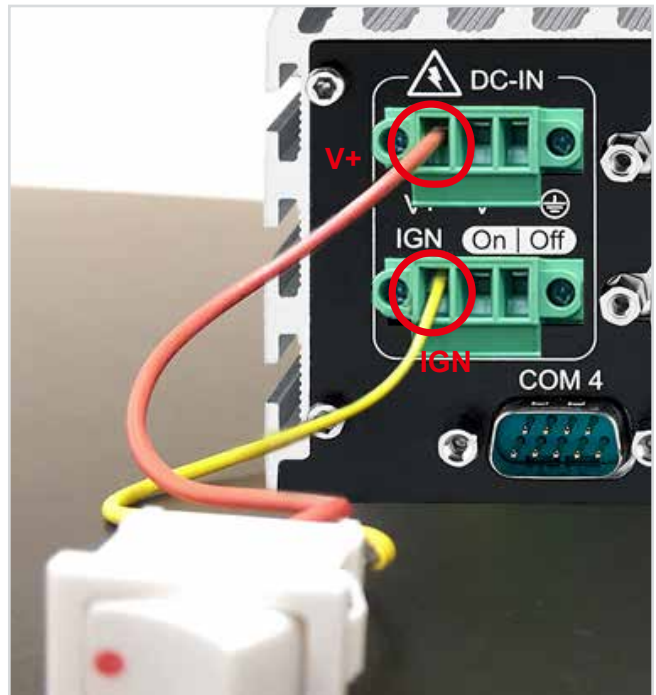

For testing purpose, you can refer to the picture above to simulate ignition signal input controlled by a latching switch.

Note:

1. DC power source and IGN share the same ground.
2. ECS-9771 supports 6V to 36V wide range DC power input in ATX/AT mode. In ignition mode, the input voltage is fixed to 12V/24V for car battery scenario.
3. For proper ignition control, the power button setting should be “Power down” mode.

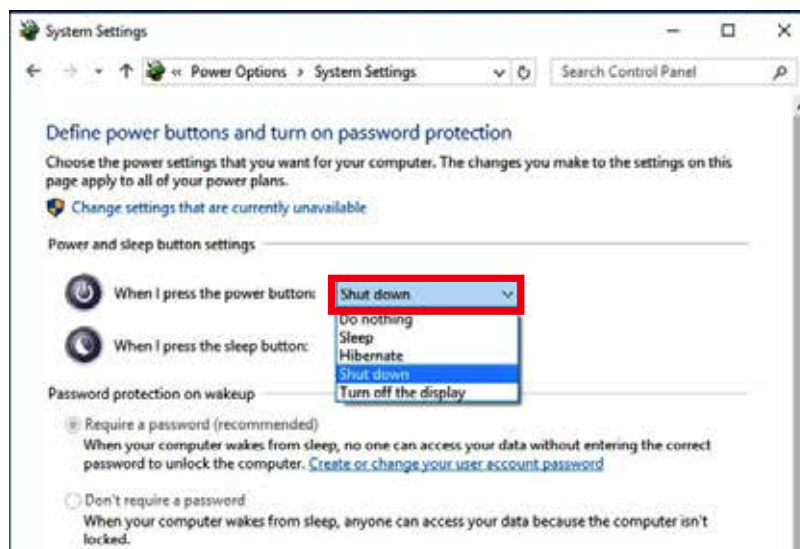

In Windows, for example, you need to set “When I press the power button” to “Shut down.”

2.6.3 Smart Battery Protection

The system with “Ignition Control” can perform Smart Battery Protection, namely Low Battery Detection.

When the system is running on a battery and its voltage drops below the threshold, the system will automatically shut down. The Low Battery Detection is implemented in the ignition control MCU FW and as a default function.

Note:

Battery Voltage	Thresholds
12V	10.5~15V
24V	21.5~30V

3

SYSTEM SETUP

3.1 How to Open Your ECS-9771

Step 1 Remove SSD/HDD tray panel.



Step 2 Remove one KHS#6-32 screw (circled in red) and four F-#6-32 screws (circled in yellow).



Step 3 Remove six KHS#6-32 screws on the rear panel.



Step 4 Remove bottom side.

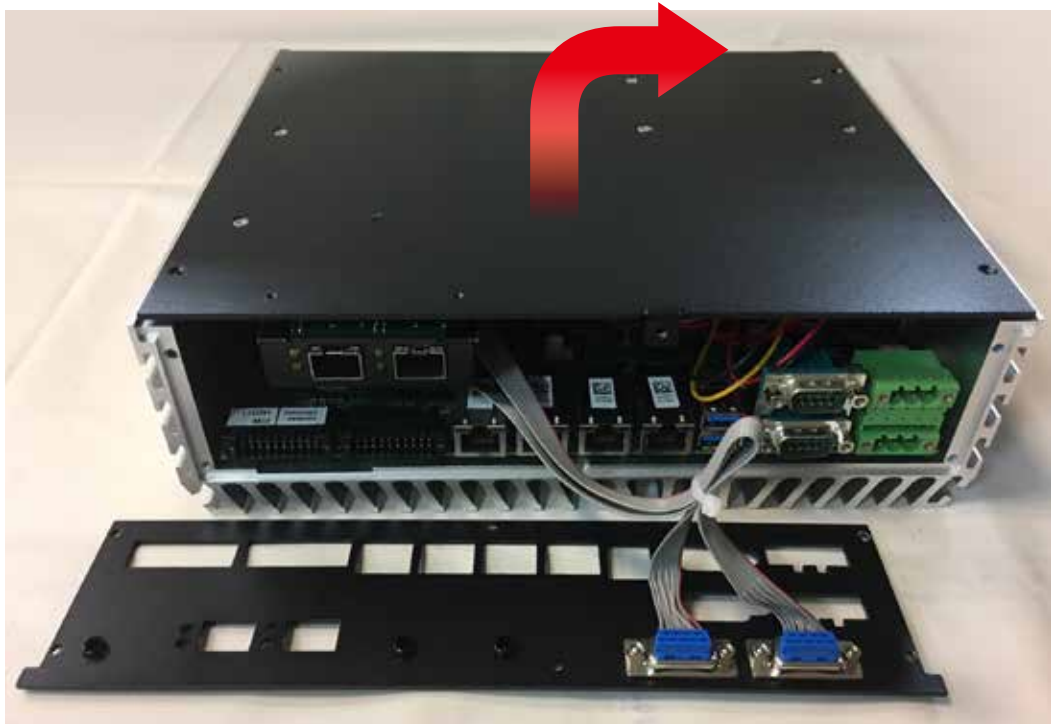

Step 5 Remove cables.



Step 6 Remove two SATA, COM and one power cable.



Step 7 Finish.



3.2 Installing DDR4 SO-DIMM Modules

Step 1 DDR4 RAM module into SO-DIMM slot.



Step 2 Make sure the RAM module is locked by the memory slot.

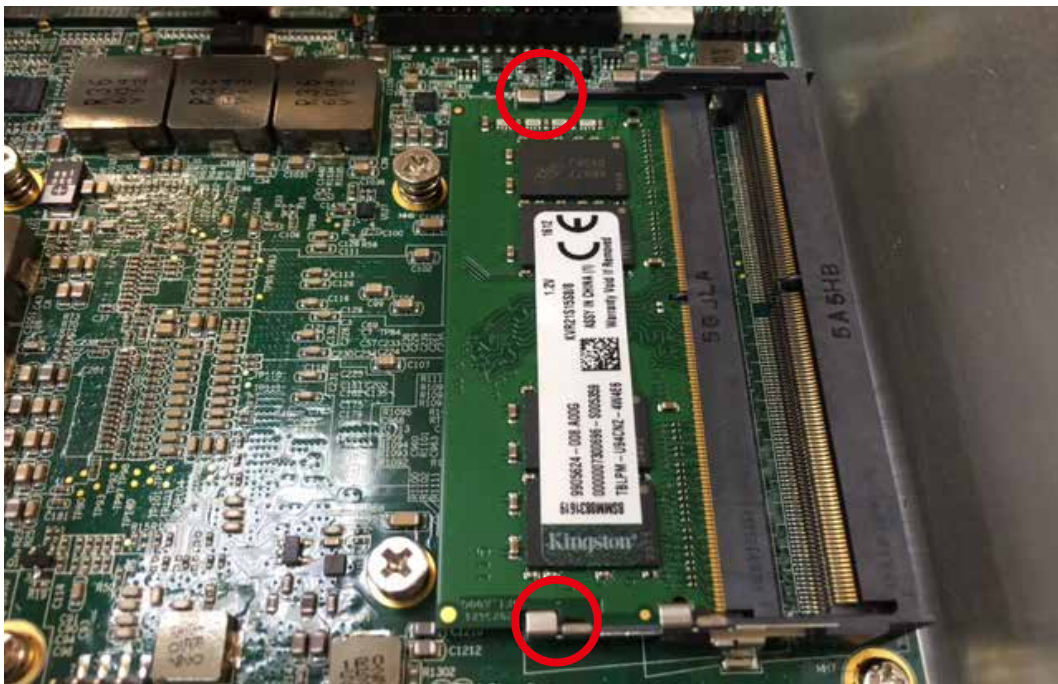

3.3 Installing Mini PCIe Card

Step 1 Install Mini PCIe card into the Mini PCIe socket.



Step 2 Fasten one M2.5 screw.



3.4 Installing CFast Card

Step 1 Remove 2 pcs F-M3x4 screws on CFast & SIM Card.



Step 2 Before inserting CFast & SIM Card, make sure ECS-9771 power is not plugged.

Step 3 Insert CFast card and push to lock.

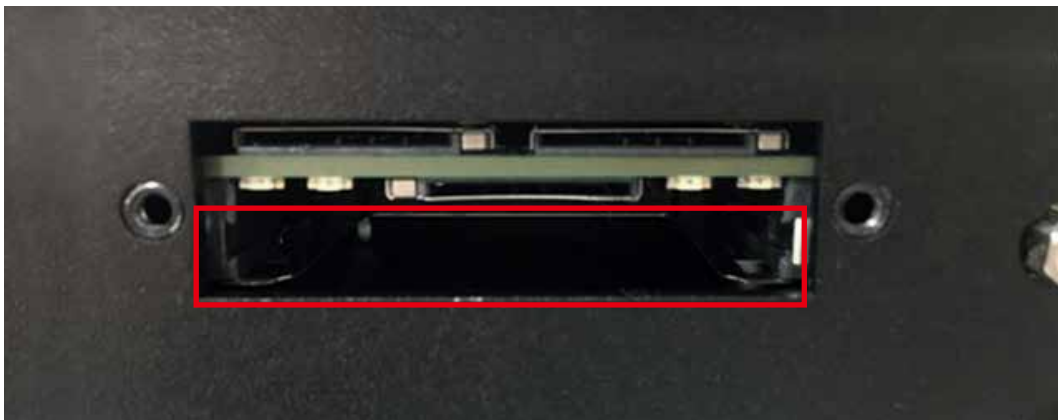

Step 4 Insert CFast card and push to lock.



3.5 Installing SIM Card

Step 1 Remove 2 pcs F-M3x4 screws on CFast & SIM Card.



Step 2 Before inserting CFast & SIM Card, make sure ECS-9771 power is not plugged.

Step 3 Insert CFast card and push to lock.



Step 4 Insert SIM card and push to lock.



3.6 Installing SSD/HDD

Step 1 Trigger and open SSD/HDD tray.



Step 2 Insert 2.5" SSD/HDD in the tray and fasten two F-M3x4 screws.



Step 3 Finish.



Step 4 Install SSD/HDD.



3.7 Mounting Your ECS-9771

3.7.1 Wall Mount Bracket

Step 1 Ensure the screw holes on the right and left sides of upper case match the ones on ECS-9771 wall mount bracket.

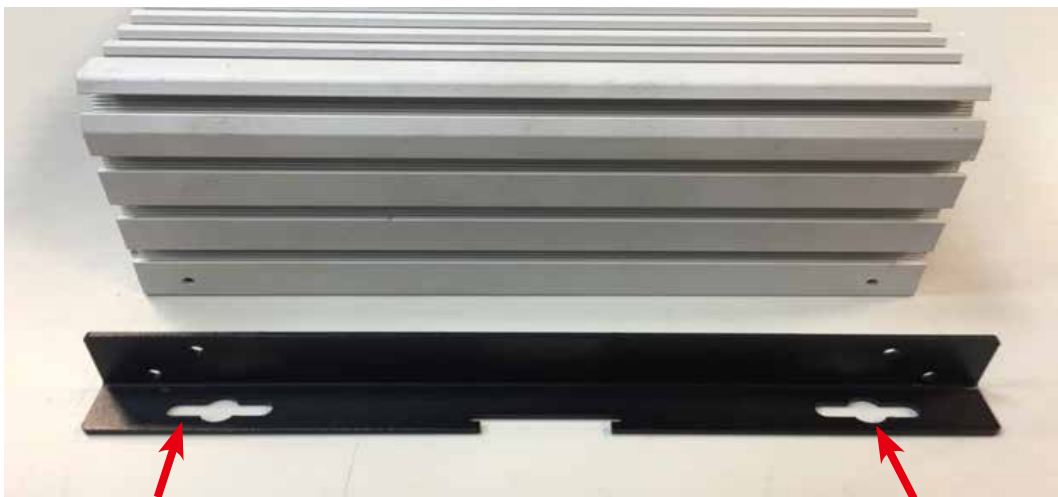

Step 2 Fasten 4pcs KHS#6-32 screws and then finish.

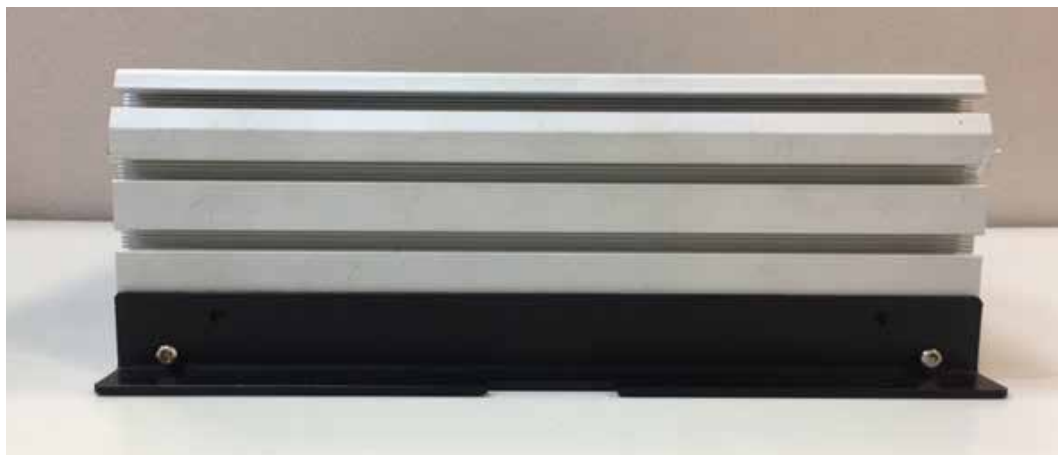

3.7.2 VESA Mount

Step 1 ECS-9771 and VESA Mount.

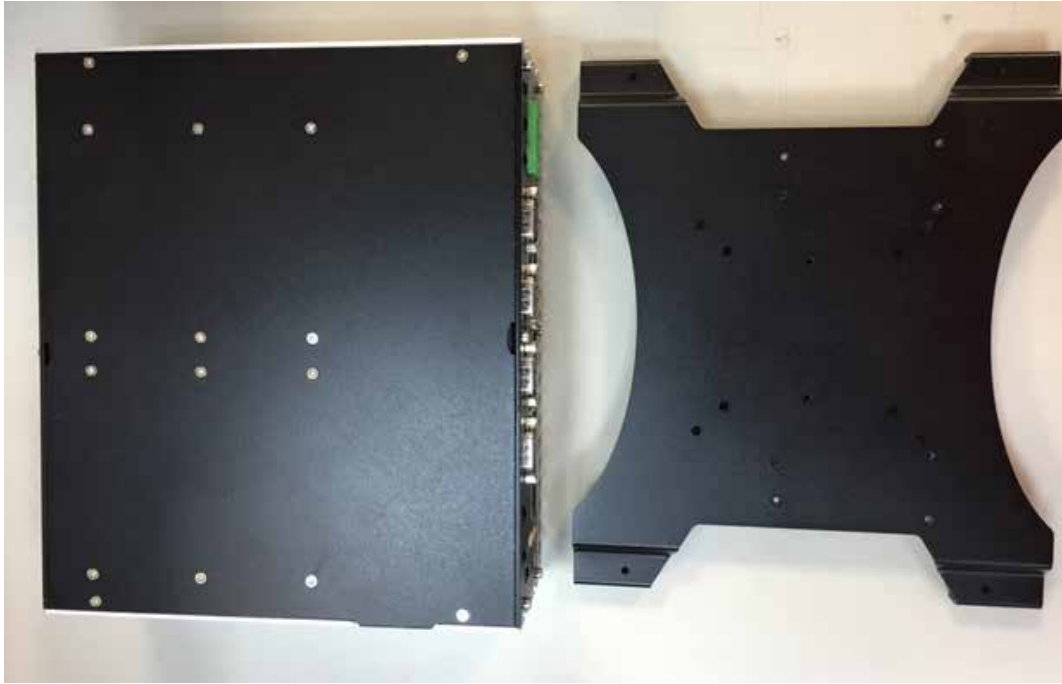

Step 2 Take ECS-9771 and VESA Mount with fasten 4pcs KHS#6-32 screws.



Step 3 Fasten four KHS#6-32 screws and then finish.



Step 4 Finish.

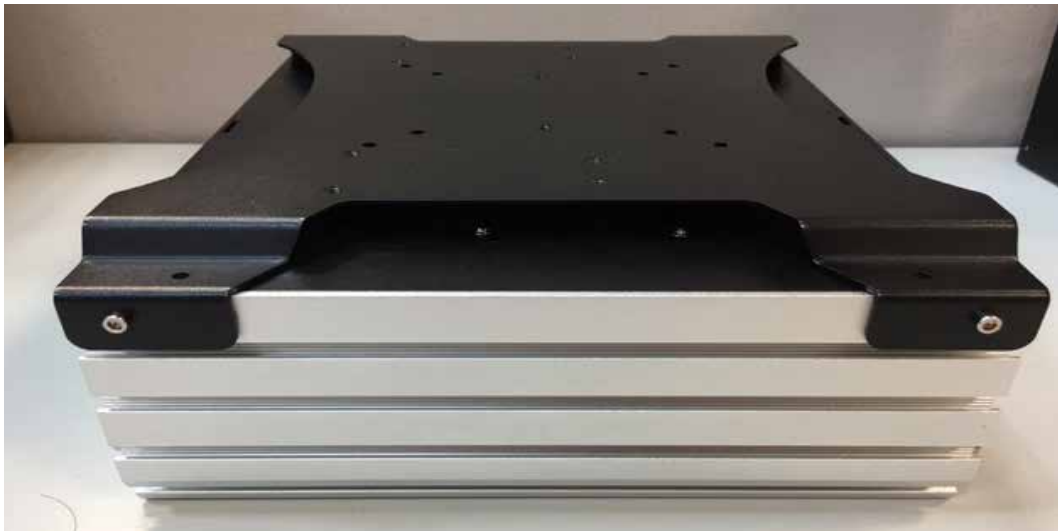

Step 5 There are two sizes of VESA Mounts, 75x75mm(red) and 100x100mm(yellow).

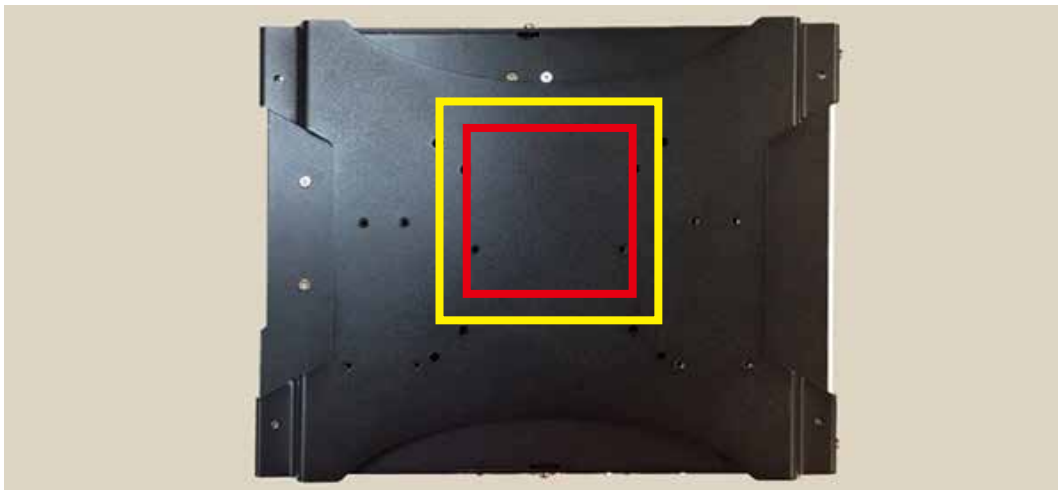

3.7.3 Din Rail Kit

Step 1 ECS-9771 and Din Rail Kit.



Step 2 Take ECS-9771 and Din Rail Kit and then fasten four KHS#6-32 screws in the four marked corners.



Step 3 Fasten four KHS#6-32 screws and then finish.



Step 4 Finish.



Step 5 ECS-9771 with Din Rail.



4

BIOS SETUP

4.1 Entering BIOS SETUP

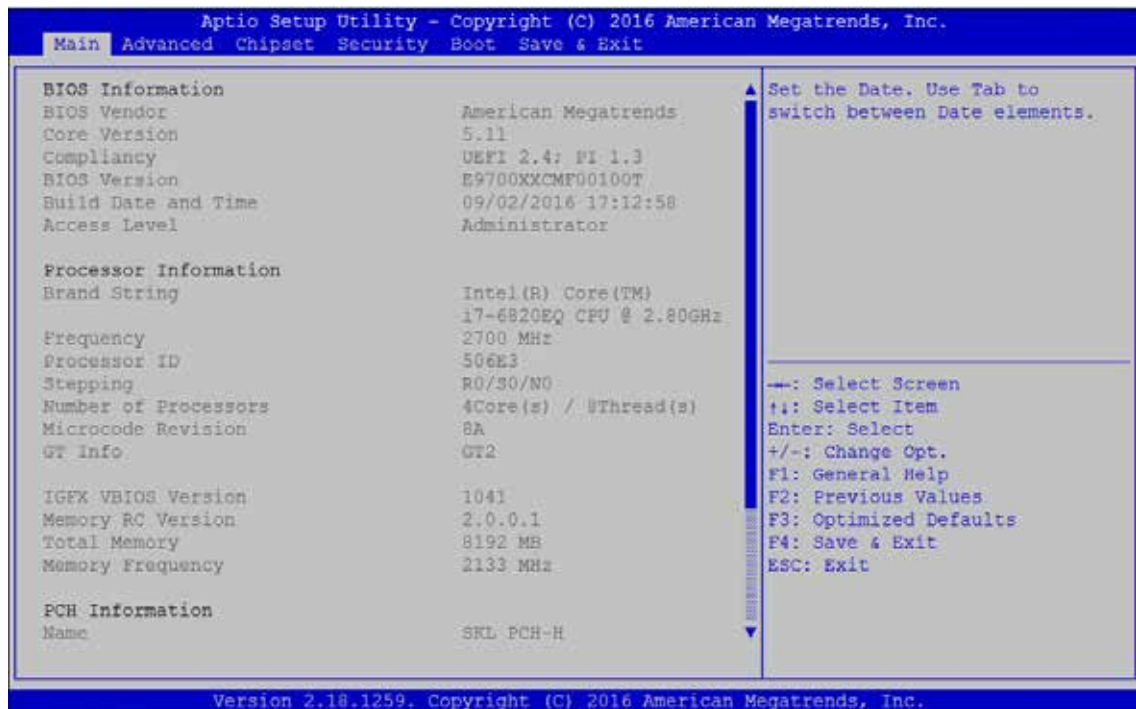

Figure 4-1: Entering Setup Screen

BIOS provides an interface for users to check and change system configuration. The BIOS setup program is accessed by pressing the key when POST display output is shown.

4.2 Main

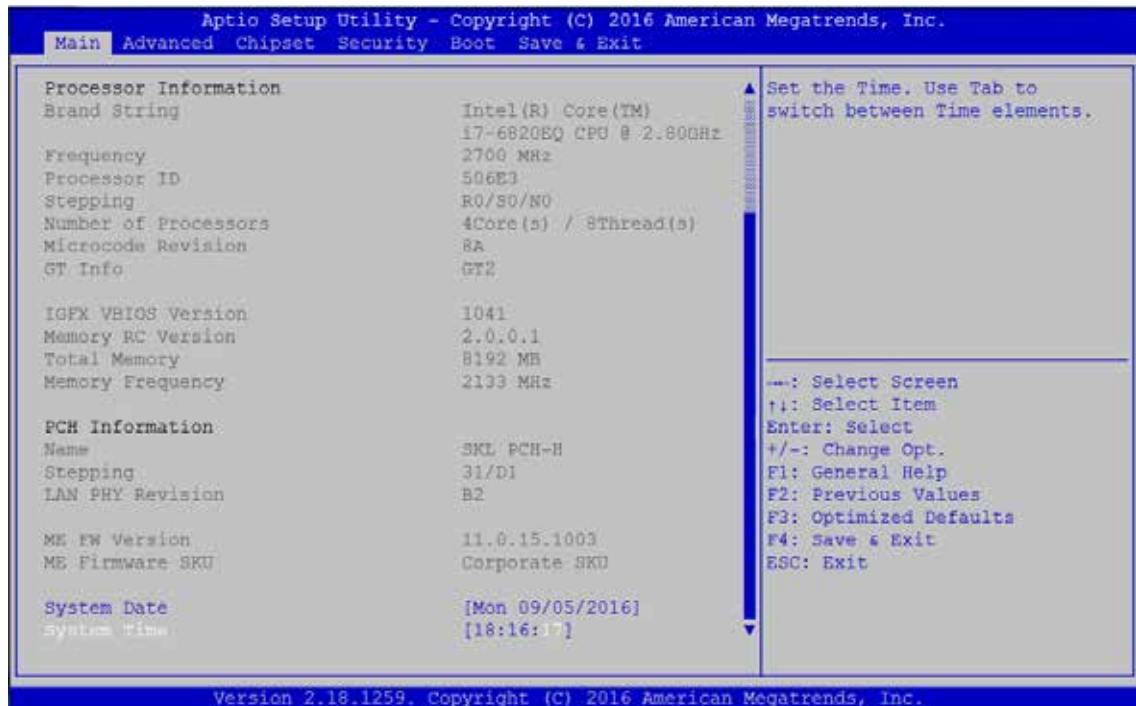

Figure 4-2: BIOS Main Menu

The main menu displays BIOS version and system information. There are two options on Main menu.

System Date

Set the date. Use <Tab> to switch between date elements.

System Time

Set the time. Use <Tab> to switch between time elements.

4.3 Advanced

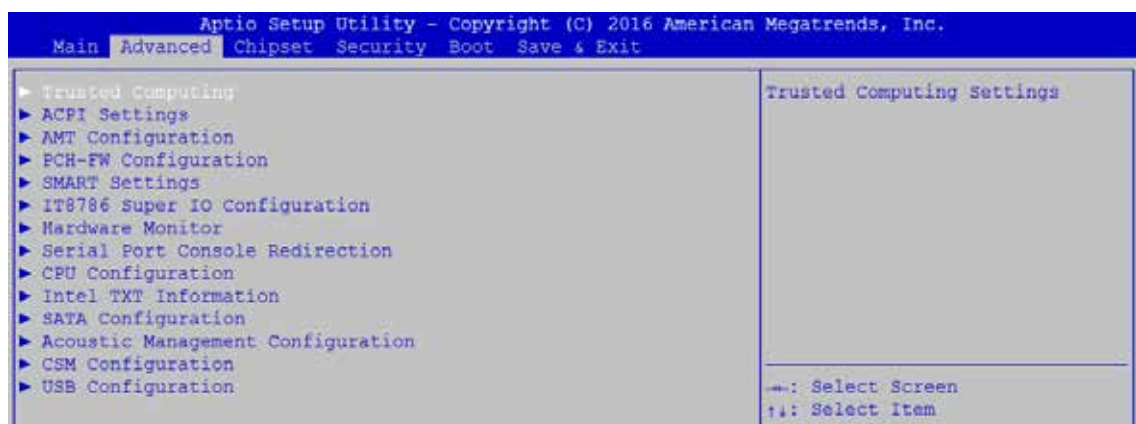

Figure 4 3: BIOS Advanced Menu

Select advanced tab to enter advanced BIOS setup options, such as CPU configuration, SATA configuration, and USB configuration.

4.3.1 Trusted Computing



Figure 4 3-1: Trusted Computing

Control the TPM device status and display related information if TPM chip is present.

4.3.2 ACPI Settings



Figure 4 3-2: ACPI Settings

Enable Hibernation

Enables or disables system's ability to hibernate (OS/S4 sleep state). This option may not be effective with some OS.

ACPI Sleep State

Selects the highest ACPI sleep state the system will enter when the SUSPEND button is pressed.

S3 Video Repost

Enables or disables S3 video repost.

ACPI Low Power S0 Idle

Enables or disables ACPI low power S0 idle support.

4.3.3 AMT Configuration



Figure 4 3-3: Intel AMT Settings

Intel AMT

Enables/disables Intel (R) Active Management Technology BIOS extension. Note: iAMT H/W is always enabled. This option just controls the BIOS extension execution. If enabled, this requires additional firmware in the SPI device.

4.3.4 PCH-FW Configuration



Figure 4 3-4: PCH-FW Settings

ME Unconfig on RTC Clear State

Disabling this option will cause ME not to unconfigure on RTC clear.

ME State

Set ME to Soft temporarily disabled.

4.3.5 SMART Settings

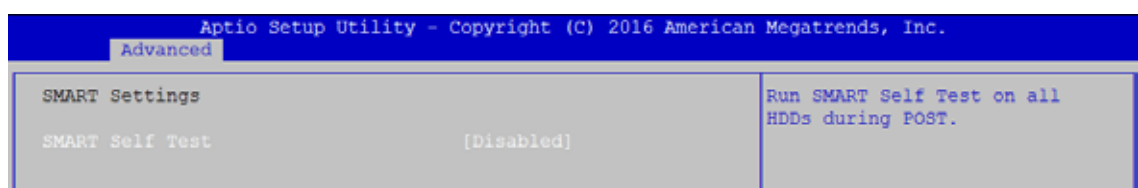

Figure 4 3-5: SMART Settings

SMART Self Test

Run SMART self test on all HDDs during POST.

4.3.6 IT8786 Super IO Configuration



Figure 4-3-6-1: Super IO Settings

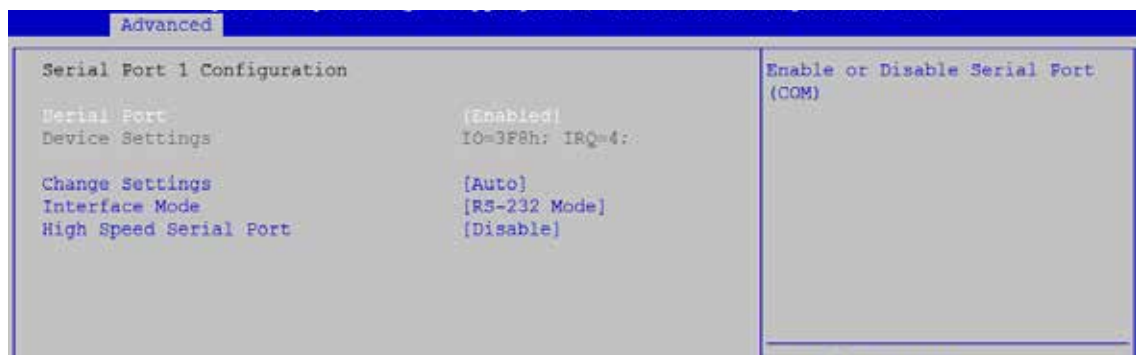

Figure 4-3-6-2: Serial Port Settings

Serial Port 1 to port 4 Configuration

Options for Serial Port 1 to Serial Port 4.

Entering the corresponding Port option then end user can change the settings such as I/O resource and UART mode.

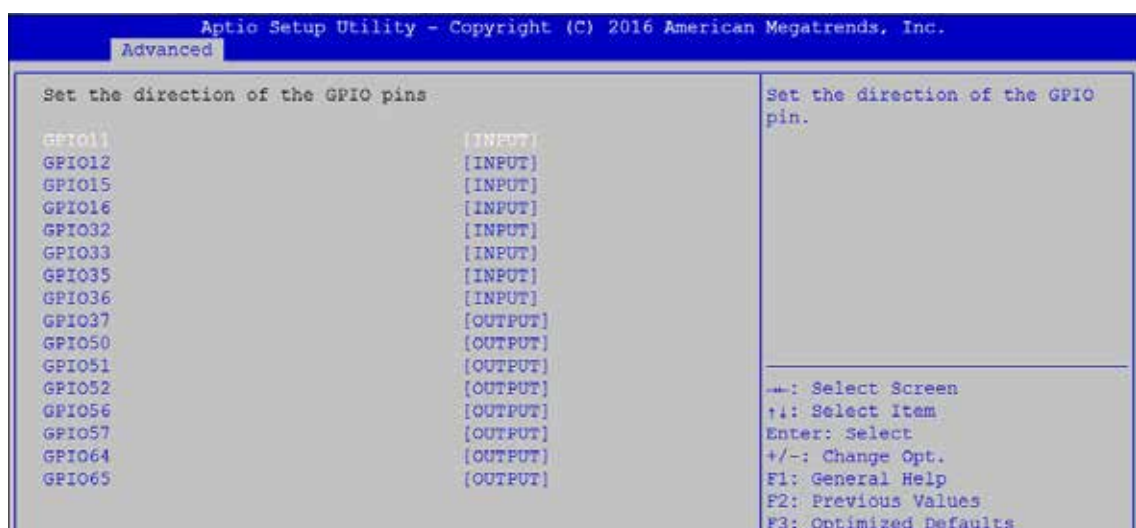

Figure 4-3-6-3: GPIO Pin Input/Output Settings of SIO IT8786

Set the direction of the GPIO pins

Creates bios options for end user to change internal GPIO pin direction.

4.3.7 Hardware Monitor

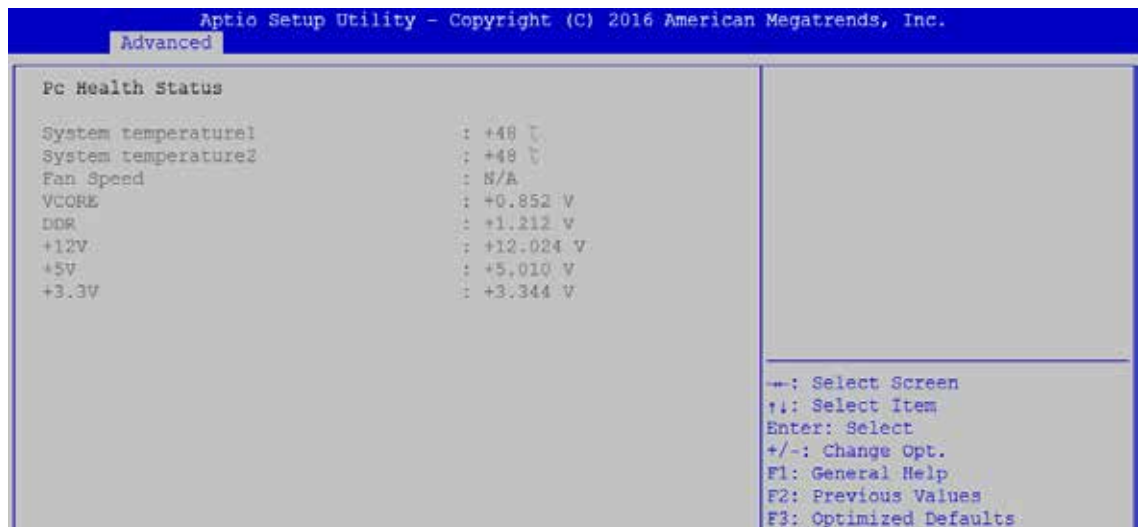

Figure 4 3-7: Hardware Monitor Settings

The IT8786 SIO features an enhanced hardware monitor providing thermal, fan speed, and system voltages' status monitoring.

4.3.8 Serial Port Console Redirection

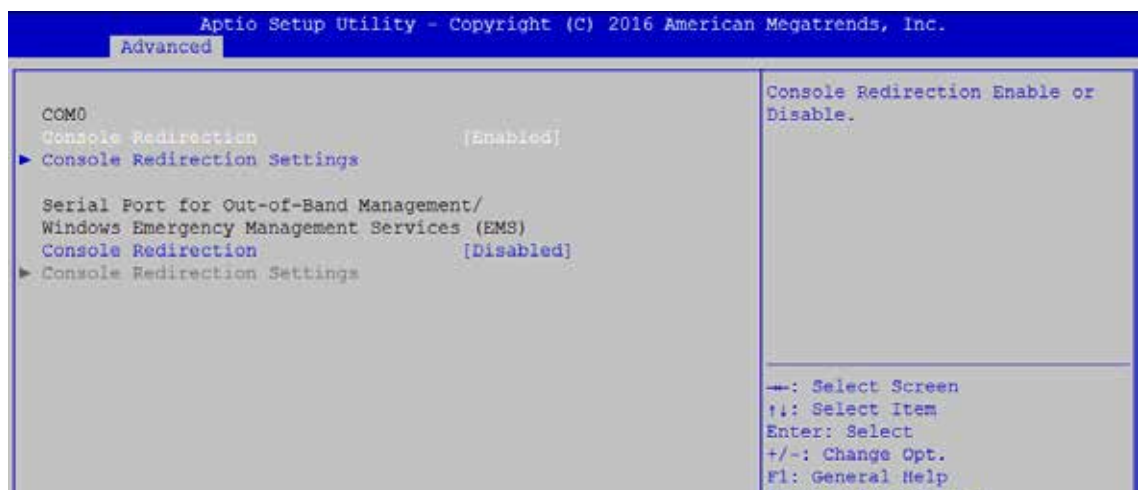

Figure 4 3-8: Serial Port Console Redirection Settings

Console Redirection

Console redirection enable or disable.

Console Redirection Settings

These settings specify how the host computer and the remote computer (which the user is using) will exchange data. Both computers should have the same or compatible settings.

4.3.9 CPU Configuration

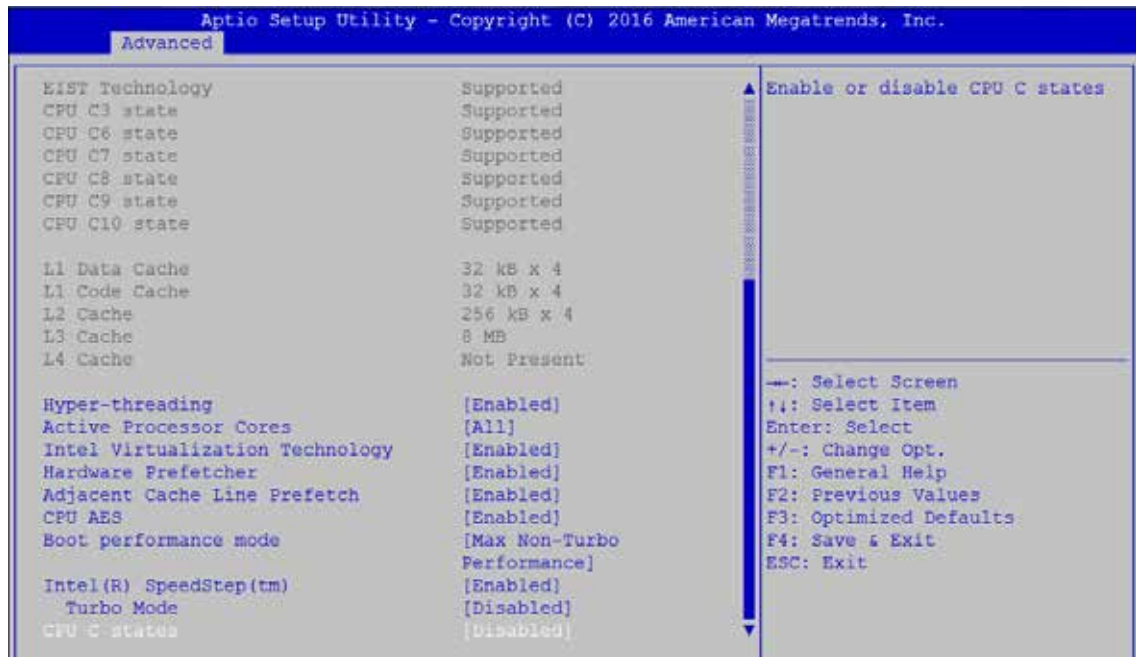

Figure 4 3-9: CPU Function Settings

Hyper-threading

Enabled for Windows XP and Linux (OS optimized for Hyper-Threading Technology) and disabled for other OS (OS not optimized for Hyper-Threading Technology). When disabled only one thread per core is enabled.

Active Processor Cores

Number of cores to enable in each processor package.

Intel Virtualization Technology

When enabled, a VMM can utilize the additional hardware capabilities provided by Vanderpool Technology.

Hardware Prefetcher

To turn on/off the MLC streamer prefetcher.

Adjacent Cache Line Prefetch

To turn on/off prefetching of adjacent cache lines.

CPU AES

Enable/disable CPU Advanced Encryption Standard instructions.

Boot performance mode

Select the performance state that the BIOS will set before OS handoff.

Intel(R) SpeedStep(tm)

Allows more than two frequency ranges to be supported.

Turbo Mode

Turbo Mode.

CPU C state

Enable or disable CPU C states.

Enhanced C-states

Enable/disable C1E. When enabled, CPU will switch to minimum speed when all cores enter C-State.

Package C State limit

Package C State limit.

Intel TXT(LT) Support

Enables or disables Intel (R) TXT (LT) support.

4.3.10 Intel TXT Information

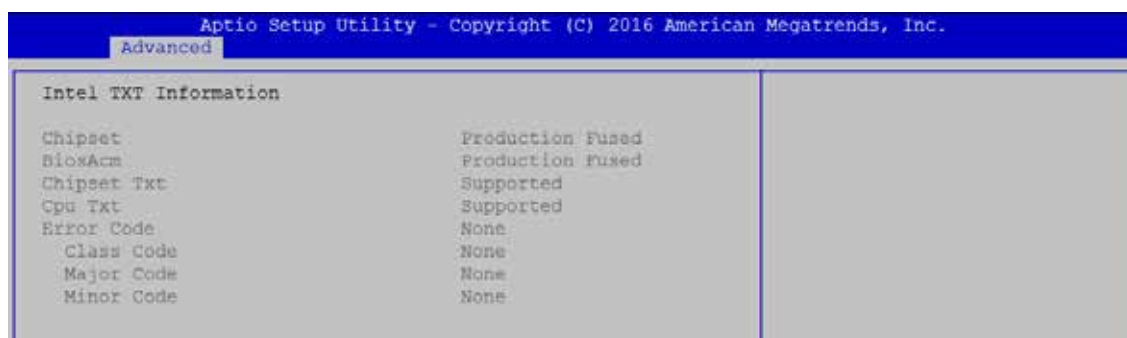

Figure 4 3-10: Intel TXT Information

Display Intel TXT information.

4.3.11 SATA Configuration

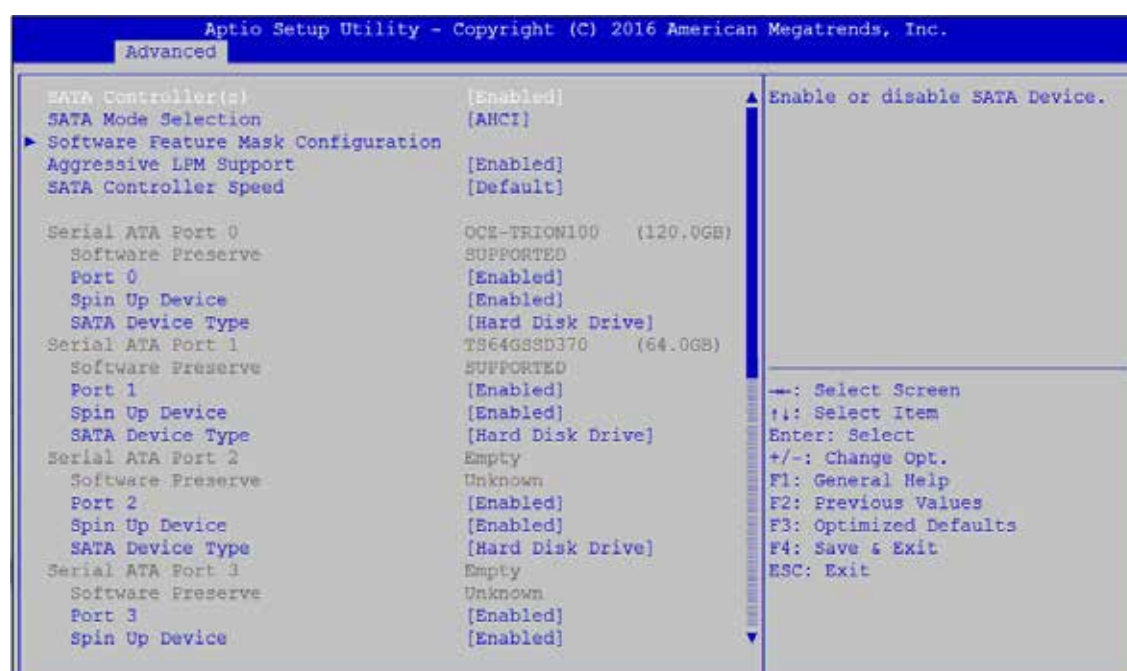

Figure 4 3-11: SATA Devices Settings

SATA Controller(s)

Enable or disable SATA Device.

SATA Mode Selection

Determines how SATA controller(s) operate.

Software Feature Mask Configuration

RAID OROM/RST driver will refer to the SWFM configuration to enable or disable the storage features.

Aggressive LPM Support

Enable PCH to aggressively enter link power state.

SATA Controller Speed

Indicates the maximum speed the SATA controller can support.

Options for each SATA port:

Port 0

Enable or disable SATA Port.

Spin Up Device

On an edge detect from 0 to 1, the PCH starts a COMRESET initialization sequence to the device.

SATA Device Type

Identifies that the SATA port is connected to solid state drive or hard disk drive.

4.3.12 Acoustic Management Configuration

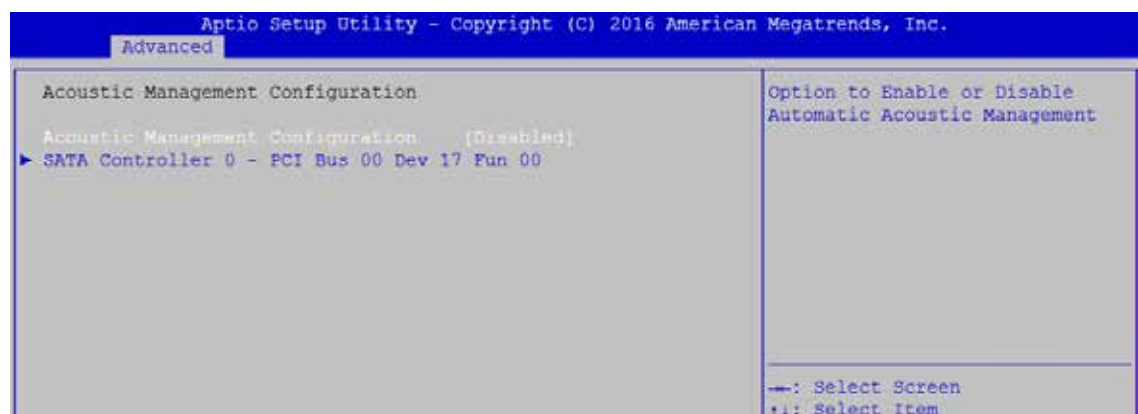

Figure 4-3-12: Acoustic Management Settings

Acoustic Management Configuration

Option to enable or disable automatic acoustic management.

4.3.13 CSM Configuration

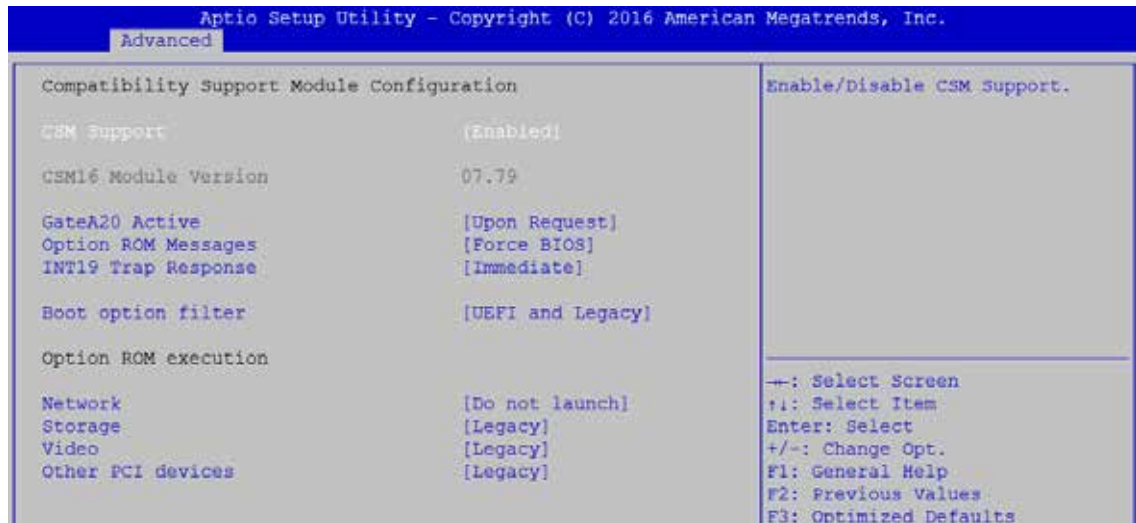

Figure 4 3-13: CSM Settings

CSM Support

Enable/disable CSM support

GateA20 Active

UPON REQUEST - GA20 can be disabled using BIOS services.

ALWAYS - do not allow GA20 to be disabled; this option is useful when any RT code is executed above 1MB.

Option ROM Messages

Set display mode for Option ROM.

INT19 Trap Response

BIOS reaction on INT19 trapping by Option ROM:

IMMEDIATE - execute the trap right away;

POSTPONED - execute the trap during legacy boot.

Boot option filter

This option controls Legacy/UEFI ROM's priority.

Network

Controls the execution of UEFI and Legacy PXE OpROM.

Storage

Controls the execution of UEFI and Legacy Storage OpROM.

Video

Allows more than two frequency ranges to be supported.

Other PCI devices

Determines OpROM execution policy for devices other than network, storage, or video.

4.3.14 USB Configuration

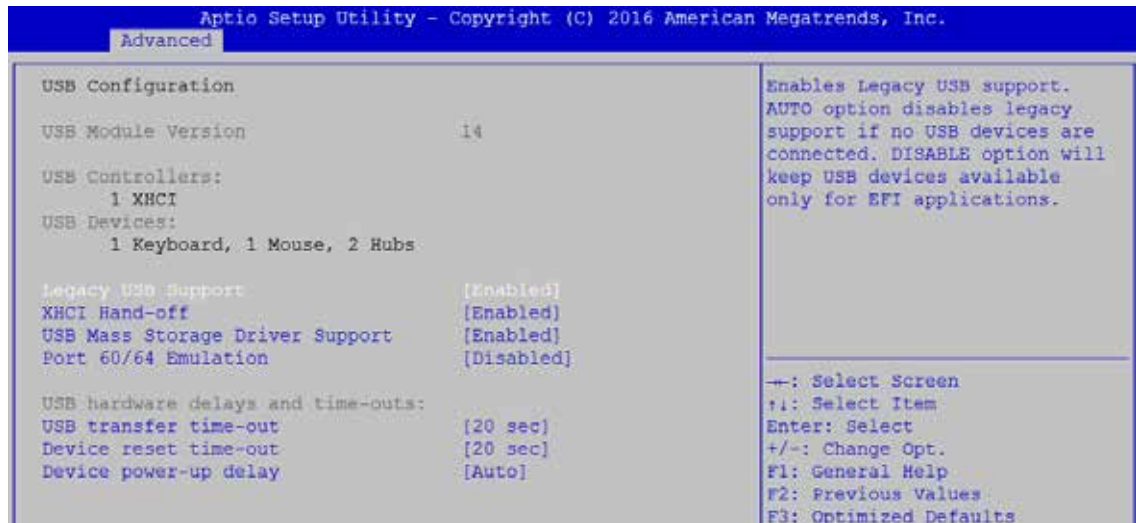

Figure 4 3-14: USB Settings

Legacy USB Support

Enables Legacy USB support.

AUTO option disables Legacy support if no USB devices are connected.

DISABLE option will keep USB devices available only for EFI applications.

XHCI Hand-off

This is a workaround for OS-es without XHCI hand-off support. The XHCI ownership change should be claimed by XHCI driver.

USB Mass Storage Driver Support

Enable/disable USB mass storage driver support.

Port 60/64 Emulation

Enables I/O port 60h/64h emulation support. This should be enabled for the complete USB keyboard legacy support for non-USB aware OS-es.

USB transfer time-out

The time-out value for control, bulk, and interrupt transfers.

Device reset time-out

USB mass storage device start unit command time-out.

Device power-up delay

Maximum time the device will take before it properly reports itself to the Host Controller. 'Auto' uses default value, for a root port it is 100 ms, for a hub port the delay is taken from the hub descriptor.

4.4 Chipset

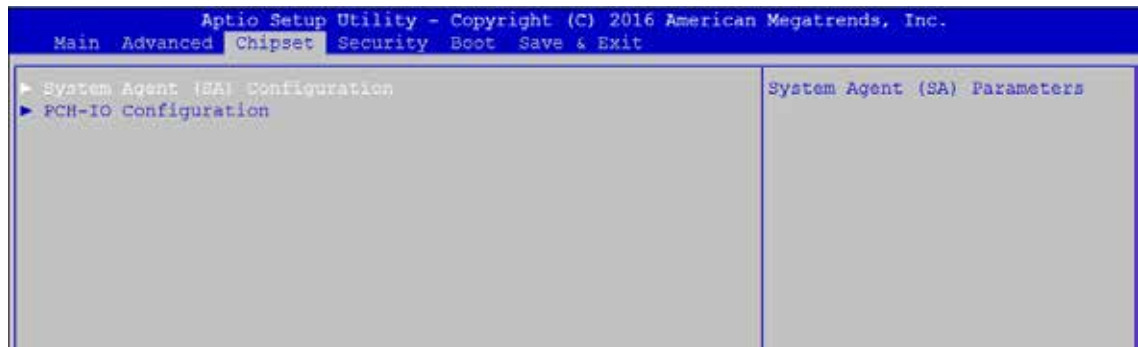

Figure 4-4: BIOS Chipset Menu

System Agent (SA) Configuration

System Agent (SA) parameters.

PCH-IO Configuration

PCH parameters.

4.4.1 System Agent (SA) Configuration

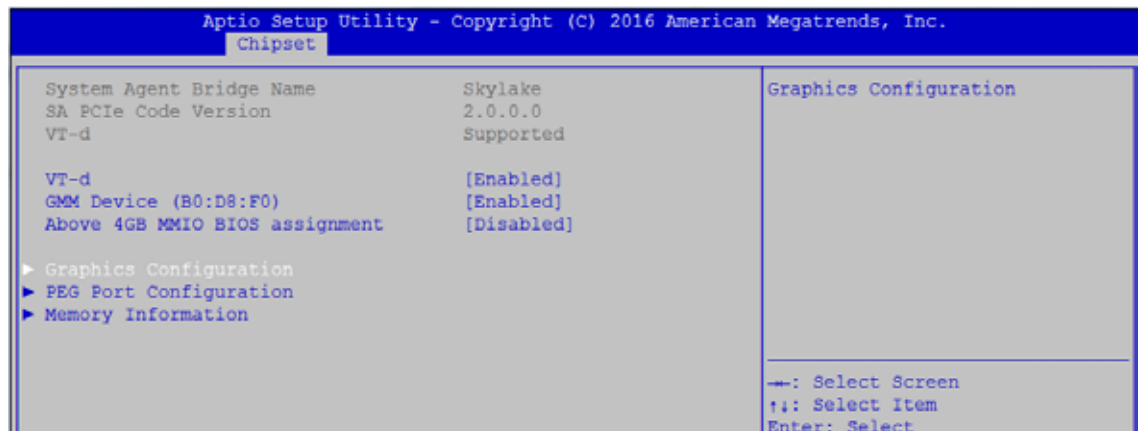

Figure 4-4-1: System Agent Settings

VT-d

VT-d capability.

GMM Device (B0:D8:F0)

Enable/disable SA GMM device.

Above 4GB MMIO BIOS assignment

Enable/disable above 4GB MemoryMappedIO BIOS assignment. This is disabled automatically when aperture size is set to 2048MB.

4.4.2 Graphics Configuration of System Agent (SA)



Figure 4-4-2: Graphics Settings

Graphics Turbo IMON Current

Graphics turbo IMON current values supported (14-31).

Skip Scanning of External Gfx Card

If Enable, it will not scan for External Gfx Card on PEG and PCH PCIE Ports.

Primary Display

Select which of IGFX/PEG/PCI Graphics device should be Primary Display Or select SG for Switchable Gfx.

GTT Size

Select the GTT Size.

Aperture Size

Select the Aperture Size.

Note: Above 4GB MMIO BIOS assignment is automatically enabled when selecting 2048MB aperture. To use this feature, please disable CSM Support.

DVMT Pre-Allocated

Select DVMT 5.0 Pre-Allocated (Fixed) Graphics Memory size used by the Internal Graphics Device.

DVMT Total Gfx Mem

Select DVMT5.0 Total Graphic Memory size used by the Internal Graphics Device.

Cd Clock Frequency

Select the highest Cd Clock frequency supported by the platform.

4.4.3 PEG Port Configuration (SA)

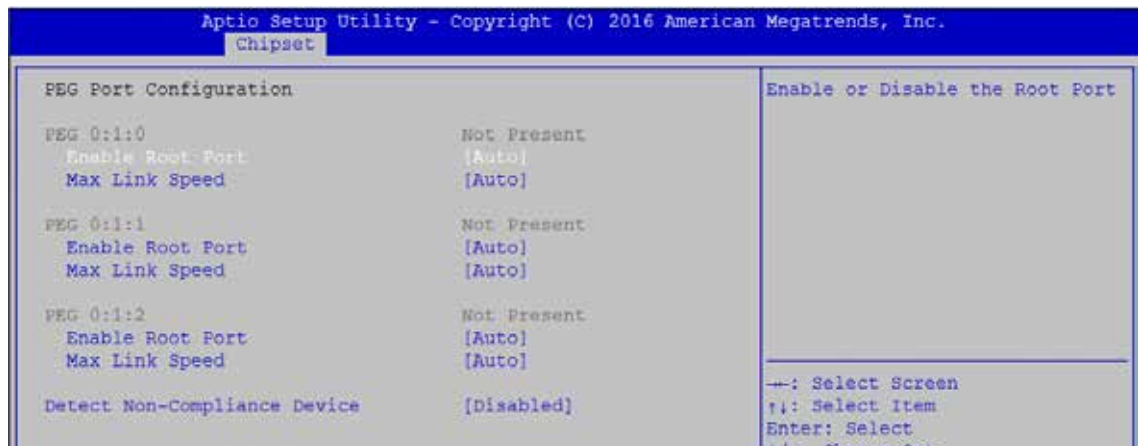

Figure 4-4-3: PEG Port Configuration

PEG port options for PCIe device.

4.4.4 Memory Information of System Agent (SA)

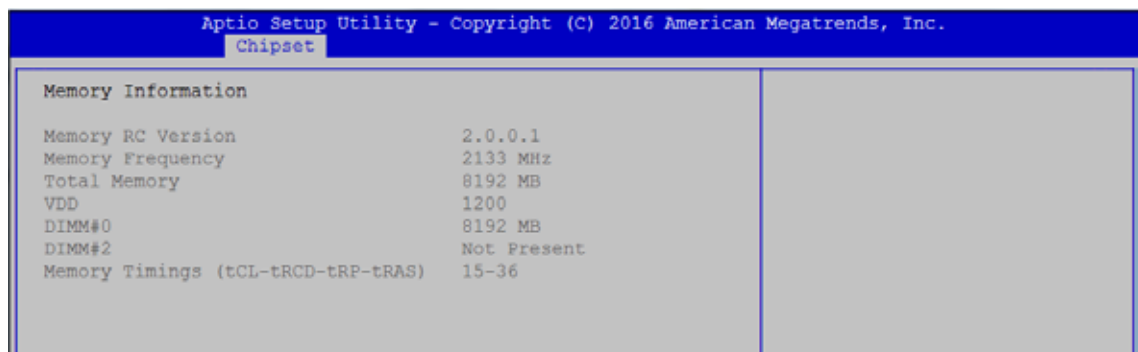

Figure 4-4-4: Memory Information

Displays memory information.

4.4.5 PCH-IO Configuration



Figure 4-4-5: PCH-IO Settings

PCI LAN Controller

Enable or disable onboard NIC.

Wake on LAN

Enable or disable integrated LAN to wake the system. (The wake On LAN cannot be disabled if ME is on at Sx state.)

Serial IRQ Mode

Configure serial IRQ mode.

State After G3

Specify what state to go to when power is re-applied after a power failure (G3 state).

S0 State: Always turn-on the system when power source plugged-in.

S5 State: Always turn-off the system when power source plugged-in.

4.4.6 PCI Express Configuration of PCH-IO

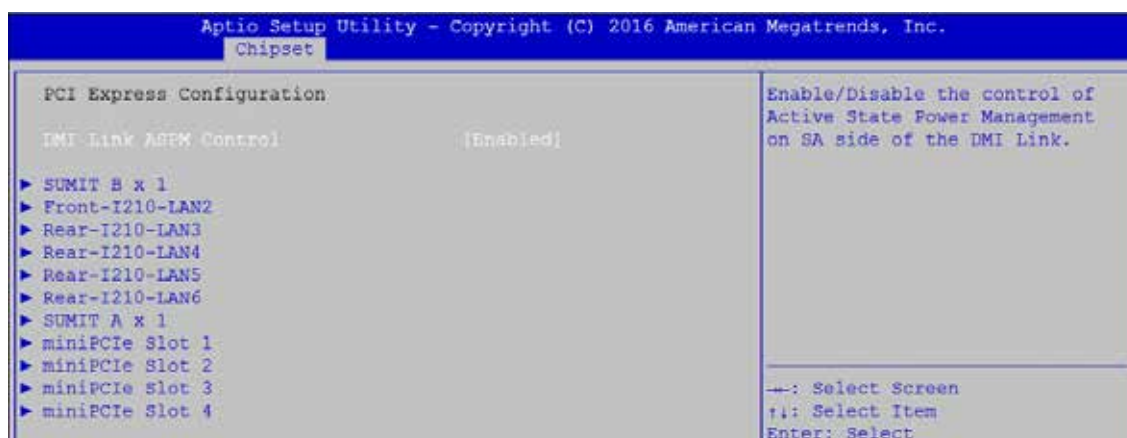

Figure 4-4-6: PCH-IO Settings

DMI Link ASPM Control

Enable/Disable the control of Active State Power Management on SA side of the DMI Link.

SUMIT B x 1

Enable or disable PCIe device on SUMIT B.

Front-I210-LAN2

Enable or disable I210 LAN.

Rear-I210-LAN3 to LAN6

Enable or disable I210 LAN.

SUMIT A x 1

Bios options for PCIe device on SUMIT A.

Mini PCIe Slot 1 to 4

Bios options for PCIe devices on miniPCIe Slot.

4.4.7 BIOS Security Configuration of PCH-IO

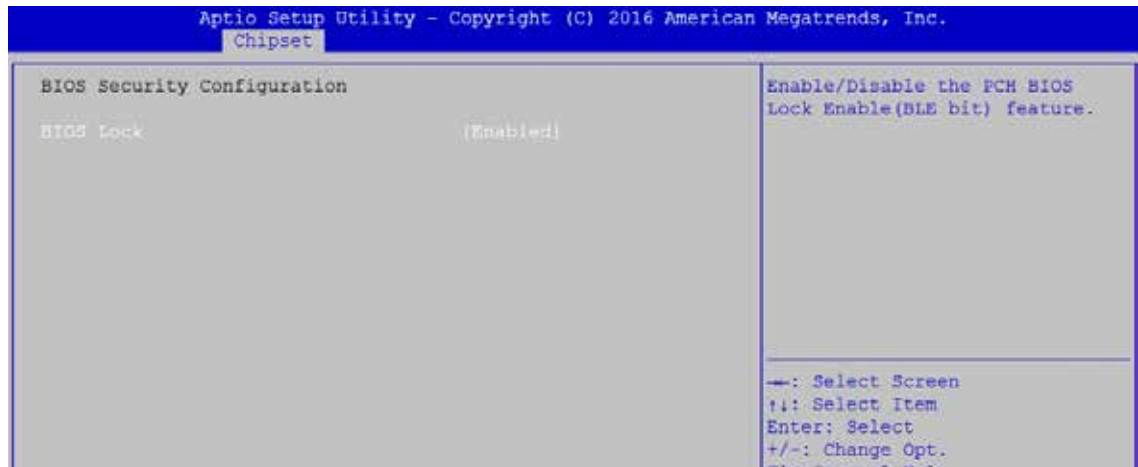

Figure 4-4-7: BIOS Security Settings

BIOS Lock

Enable/disable the PCH BIOS Lock Enable (BLE bit) feature.

4.4.8 SB Porting Configuration of PCH-IO

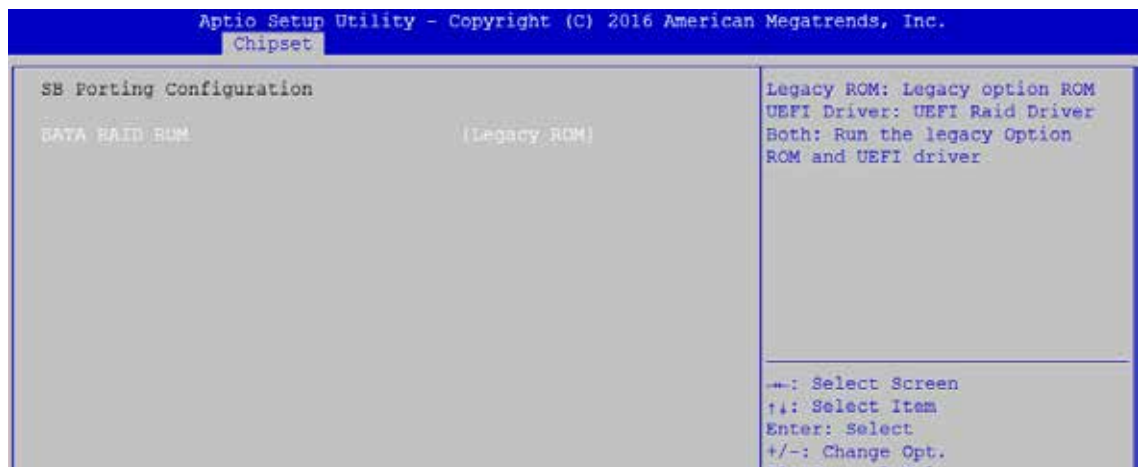

Figure 4-4-8: RAID ROM Settings

SATA RAID ROM

Legacy ROM: Legacy option ROM

UEFI Driver: UEFI Raid Driver

Both: Run the Legacy Option ROM and UEFI driver.

4.5 Security

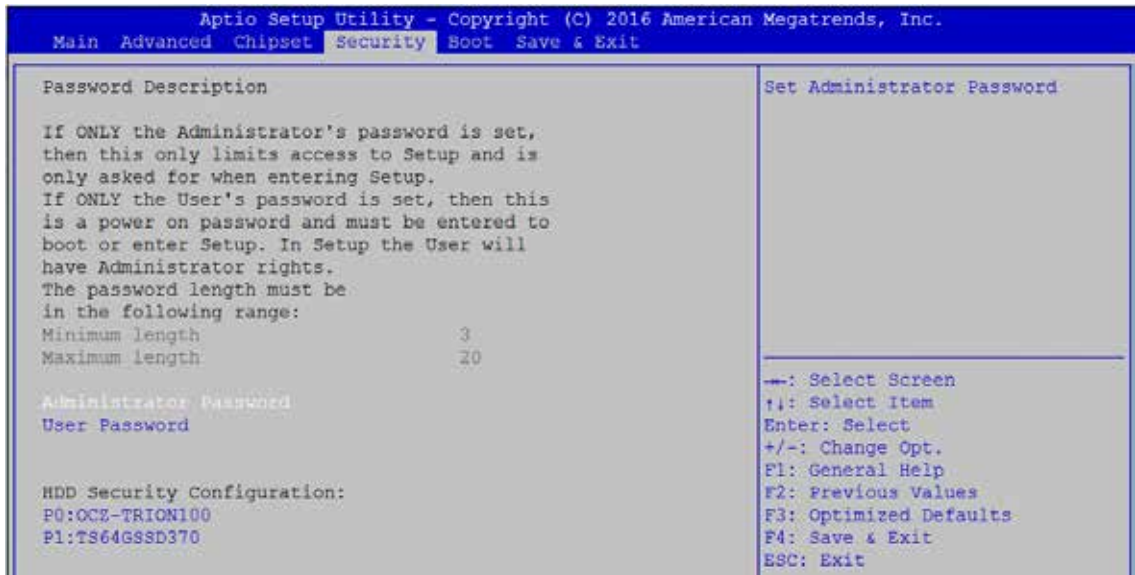

Figure 4-5: BIOS Security Menu

Administrator Password

Set administrator password.

User Password

Set user password.

4.5.1 HDD Security Configuration

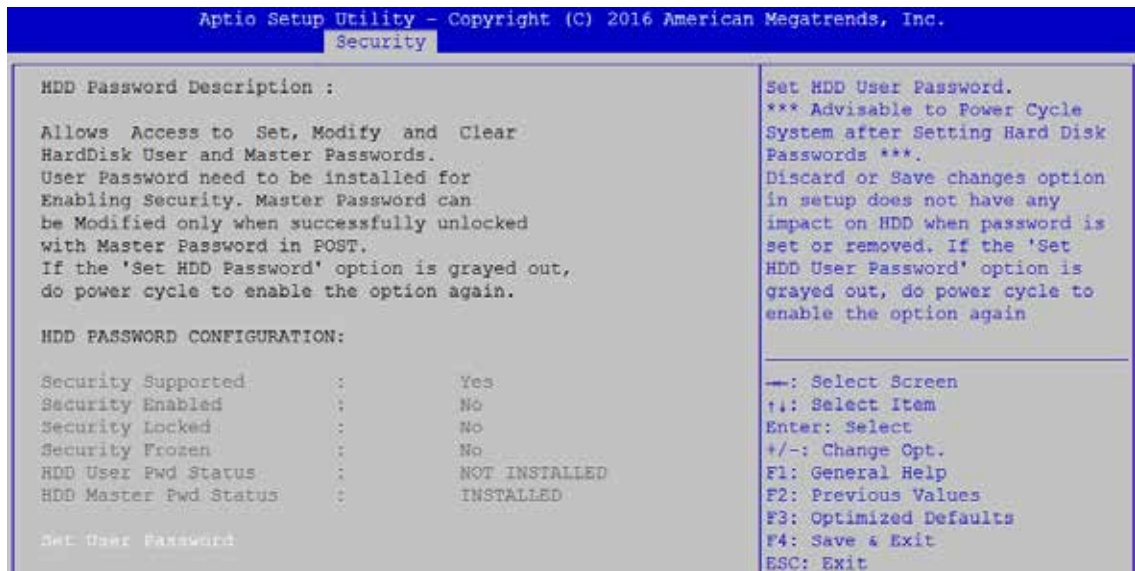

Figure 4-5-1: HDD Security Settings

Set User Password

Set HDD user password.

*** Advisable to power cycle system after setting hard disk passwords ***

Discard or save changes option in setup does not have any impact on HDD when password is set or removed. If the 'Set HDD User Password' option is gray, do power cycle to enable the option again.

4.6 Boot

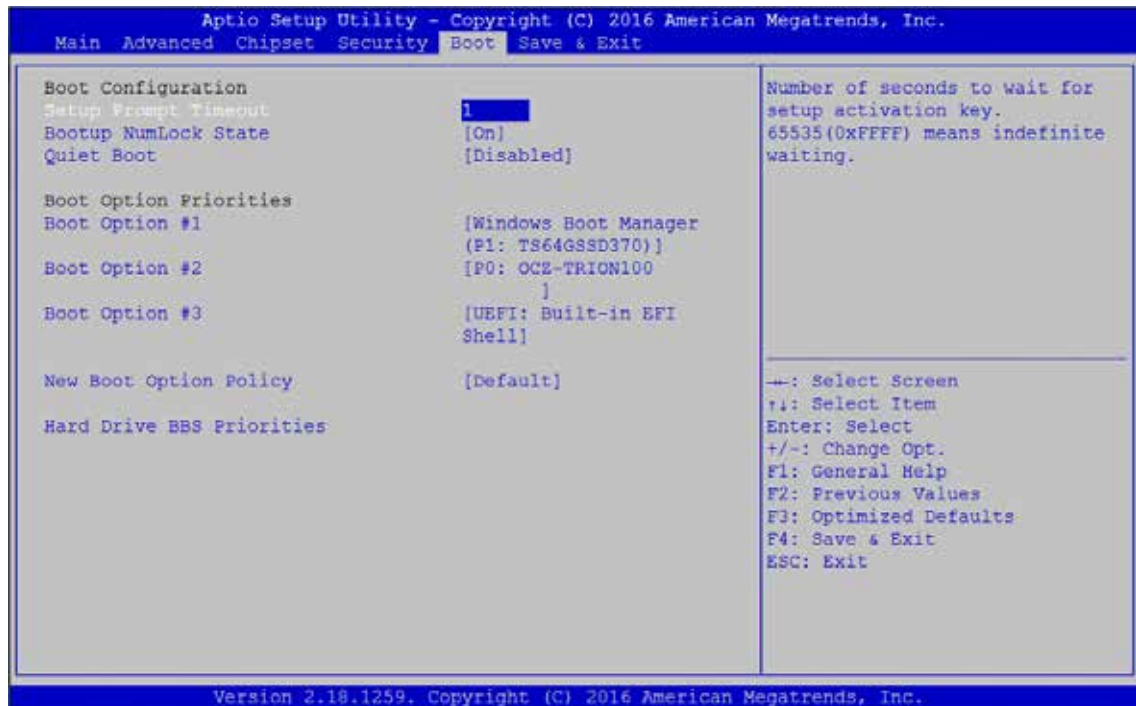

Figure 4-6: BIOS Boot Menu

Setup Prompt Timeout

Number of seconds to wait for setup activation key. 65535(0xFFFF) means indefinite waiting.

Bootup NumLock State

Select the keyboard NumLock state.

Quiet Boot

Enables or disables Quiet Boot option.

Boot Option

Sets the system boot order.

New Boot Option Policy

Controls the placement of newly detected UEFI boot options.

Hard Drive BBS Priorities

Set the order of the Legacy devices in this group.

4.7 Save & Exit

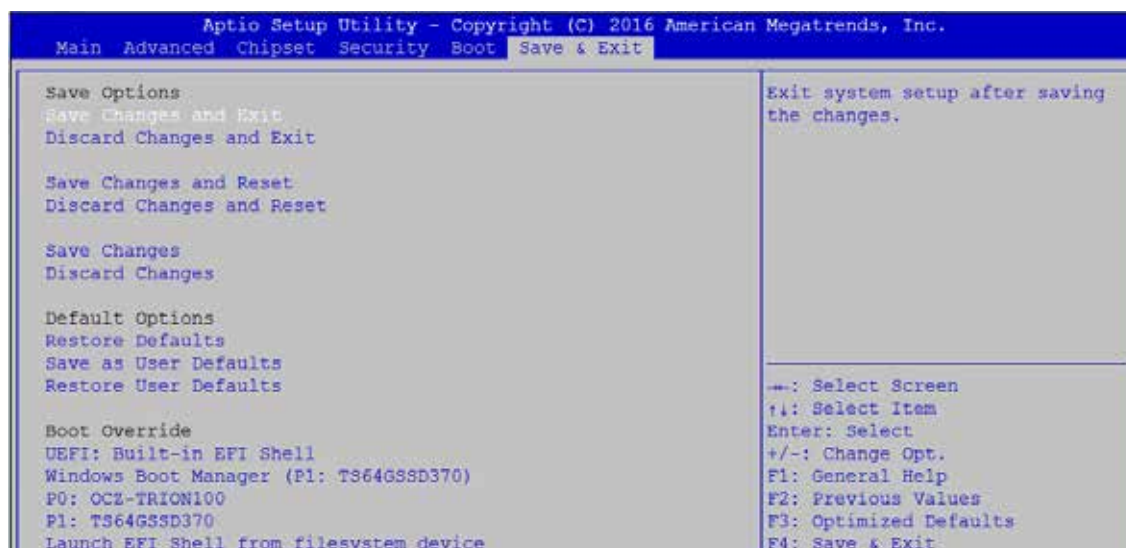

Figure 4-7: Bios Save and Exit Menu

Save Changes and Exit

Exit system setup after saving the changes.

Discard Changes and Exit

Exit system setup without saving any changes.

Save Changes and Reset

Reset the system after saving the changes.

Discard Changes and Reset

Reset system setup without saving any changes.

Save Changes

Save changes done so far to any of the setup options.

Discard Changes

Discard changes done so far to any of the setup options.

Default Options:

Restore Defaults

Restore/load default values for all the setup options.

Save as User Defaults

Save the changes done so far as user defaults.

Restore User Defaults

Restore the user defaults to all the setup options.

A

APPENDIX A : Isolated DIO Guide

A.1 Function Description

The ECS-9771 offers two 16-bit DIO (8-DI/ 8-DO) 20-pin terminal block connector. Each bit of DI and DO is equipped with a photo-coupler for isolated protection. All IO pins are fixed by Hardware design and cannot change in/out direction in runtime process. The definition is listed as follows:

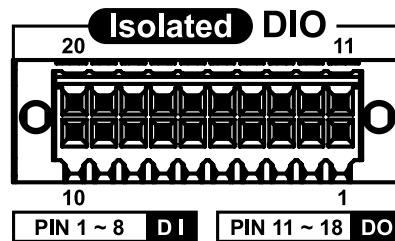

Pin No.	Definition	Description	Pin No.	Definition	Description
1	EXT_IN0	DI0	11	EXT_OUT0	DO0
2	EXT_IN1	DI1	12	EXT_OUT1	DO1
3	EXT_IN2	DI2	13	EXT_OUT2	DO2
4	EXT_IN3	DI3	14	EXT_OUT3	DO3
5	EXT_IN4	DI4	15	EXT_OUT4	DO4
6	EXT_IN5	DI5	16	EXT_OUT5	DO5
7	EXT_IN6	DI6	17	EXT_OUT6	DO6
8	EXT_IN7	DI7	18	EXT_OUT7	DO7
9	DI_COM	DI COM	19	Reserved	NC
10	EGND	DIO GND	20	E24V	External 24V DC

A.2 DIO Signal Circuit

DI reference circuit:

Sink Mode (NPN)

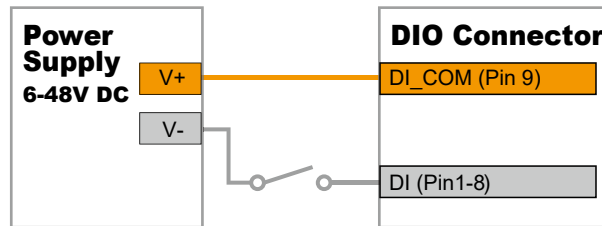

Source Mode (PNP)

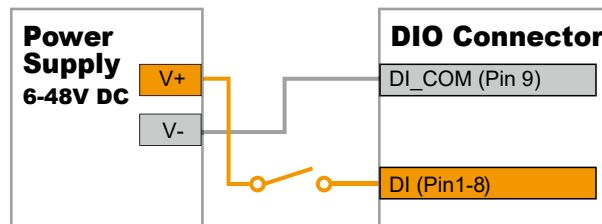

DO reference circuit:

Sink Mode
(NPN, Default)

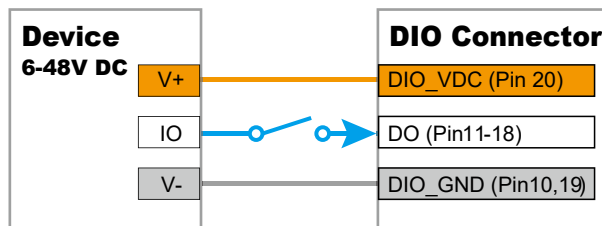

Source Mode
(PNP)

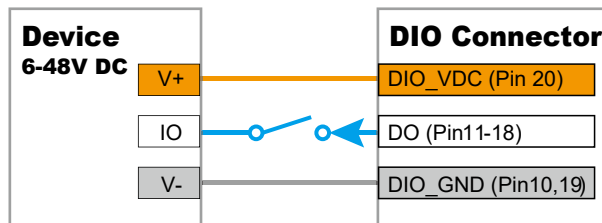

A.3 Software Package Contain

Distribution folder include x32 and x64 versions, use batch file for installation. Win7_64.bat included Windows Update packages which driver required (OS need to Restart after installing).

If the OS version is Windows 8/8.1/10 the batch file Win8_32.bat, Win8_64.bat, Win10_32.bat, and Win10_64.bat will install Framework 3.5 distribution for the sample utility. If Source code compile by Framework 4 it doesn't need to install above batch file. Run batch file as Administrator.

Runtime folder include head file for software developer or System Integration. Sample folder include Sample program, Driver package, and Driver API library. Source folder include Sample program source code that compile on Visual Studio 2008.

This driver support to 32bit and 64bit version that are Windows 7 above. Please make Sure you OS before you install it.

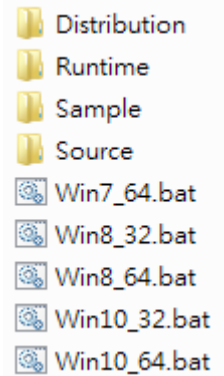

A.4 DIO Demo Tool

Execute DIO demo tool (ECS9K7.exe).

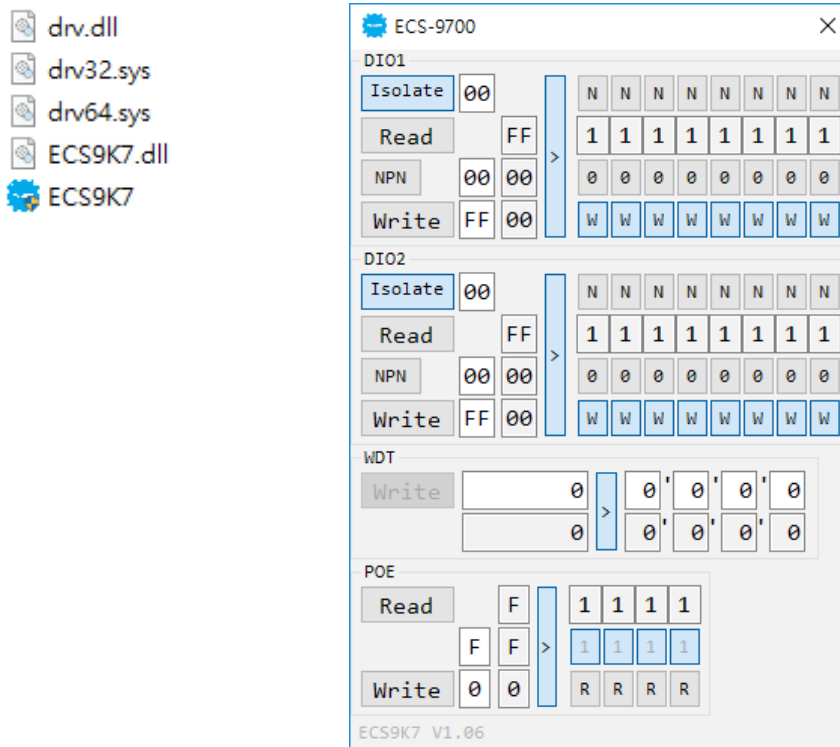

Operation on DIO / WDT / PoE Demo tool utility.

Click “Isolate” checked button for isolate / non-isolated DIO setup (customized version);

Click “N” / ”P” checked button for DI NPN / PNP setup (or change textbox value);

Click “NPN” / “PNP” checked button for DO NPN / PNP setup;

Click “Read” button to get value;

Input any number in Write and Write Mask textbox, and click “Write” Button to set value;

Click “Stop” button to cancel WDT (watchdog timer) counter.

B

APPENDIX B : Software Functions

B.1 ECS9K7.DII API

In Runtime folder, on ECS9K2.h:

BOOL Initial(BYTE Isolate_Type, BYTE DIO_NPN);

Install driver and initial machine for DIO access

Isolate_Type: DIO Isolate Type

1: Isolated DIO; 0: Non-Isolated DIO

DIO_NPN: DIO NPN mode

1: PNP (Source) mode for European rule; 0: NPN (Sink) mode for Japanese rule

Return:

TRUE (1): Success; FALSE (0): Fail (Install error (privilege error, or driver not work), or Initial error, or Parameter format error)

BOOL GetDI1(BYTE *DI);

Get DIO1 input

DI: DIO1 input (DI[7:0])

Return:

TRUE (1): Success; FALSE (0): Fail (driver not work, or hardware problem)

BOOL SetDO1(BYTE DO);

Set DIO1 output

DO: DIO1 output (DO[7:0])

Return:

TRUE (1): Success; FALSE (0): Fail (driver not work, or hardware problem)

BOOL GetDO1(BYTE *DO);

Get DIO1 output

DO: DIO1 output (DO[7:0])

Return:

TRUE (1): Success; FALSE (0): Fail (driver not work, or hardware problem)

BOOL GetDI2(BYTE *DI);

Get DIO2 input

DI: DIO2 input (DI[7:0])

Return:

TRUE (1): Success; FALSE (0): Fail (driver not work, or hardware problem)

BOOL SetDO2(BYTE DO);

Set DIO2 output

DO: DIO2 output (DO[7:0])

Return:

TRUE (1): Success; FALSE (0): Fail (driver not work, or hardware problem)

BOOL GetDO2(BYTE *DO);

Get DIO2 output

DO: DIO2 output (DO[7:0])

Return:

TRUE (1): Success; FALSE (0): Fail (driver not work, or hardware problem)

BOOL GetWDT(DWORD *WDT);

Get watchdog timer

WDT: Watchdog timer

Return:

TRUE (1): Success; FALSE (0): Fail (driver not work, or hardware problem)

BOOL SetWDT(DWORD WDT);

Set watchdog timer

WDT: Watchdog timer

Return:

TRUE (1): Success; FALSE (0): Fail (driver not work, or hardware problem, or parameter format error)

BOOL CancelWDT();

Cancel watchdog timer

WDT: Watchdog timer

Return:

TRUE (1): Success; FALSE (0): Fail (driver not work, or hardware problem)

BOOL GetPOEConfig(BYTE *Mask);

Get POE enable/disable configuration

Mask: POE enable mask (Mask[7:0])

Return:

TRUE (1): Success; FALSE (0): Fail (driver not work, or hardware problem)

BOOL SetPOEConfig(BYTE Mask);

Set POE enable/disable configuration

Mask: POE enable mask (Mask[7:0])

Return:

TRUE (1): Success; FALSE (0): Fail (driver not work, or hardware problem)

BOOL GetPOE(BYTE *POE);

Get POE on/off setup

POE: POE switch (POE[7:0])

Return:

TRUE (1): Success; FALSE (0): Fail (driver not work, or hardware problem)

BOOL SetPOE(BYTE POE);

Set POE on/off setup

POE: POE switch (POE[7:0])

Return:

TRUE (1): Success; FALSE (0): Fail (driver not work, or hardware problem)

BOOL GetDIO1Config(BYTE *Isolate_Type, BYTE *DI_NPN, BYTE *DO_NPN);

Get DIO1 configuration

Isolate_Type: DIO1 Isolate Type

1: Isolated DIO; 0: Non-Isolated DIO

DI_NPN: DIO1 input NPN mode (DI_NPN[7:0])

1: PNP (Source) mode for European rule; 0: NPN (Sink) mode for Japanese rule

DO_NPN: DIO1 output NPN mode

1: PNP (Source) mode for European rule; 0: NPN (Sink) mode for Japanese rule

Return:

TRUE (1): Success; FALSE (0): Fail (driver not work, or hardware problem)

BOOL Set DIO1Config(BYTE Isolate_Type, BYTE DI_NPN, BYTE DO_NPN);

Set DIO1 configuration

Isolate_Type: DIO1 Isolate Type

1: Isolated DIO; 0: Non-Isolated DIO

DI_NPN: DIO1 input NPN mode (DI_NPN[7:0])

1: PNP (Source) mode for European rule; 0: NPN (Sink) mode for Japanese rule

DO_NPN: DIO1 output NPN mode

1: PNP (Source) mode for European rule; 0: NPN (Sink) mode for Japanese rule

Return:

TRUE (1): Success; FALSE (0): Fail (driver not work, or hardware problem)

BOOL GetDIO2Config(BYTE *Isolate_Type, BYTE *DI_NPN, BYTE *DO_NPN);

Get DIO2 configuration

Isolate_Type: DIO2 Isolate Type

1: Isolated DIO; 0: Non-Isolated DIO

DI_NPN: DIO2 input NPN mode (DI_NPN[7:0])

1: PNP (Source) mode for European rule; 0: NPN (Sink) mode for Japanese rule

DO_NPN: DIO2 output NPN mode

1: PNP (Source) mode for European rule; 0: NPN (Sink) mode for Japanese rule

Return:

TRUE (1): Success; FALSE (0): Fail (driver not work, or hardware problem)

BOOL Set DIO2Config(BYTE Isolate_Type, BYTE DI_NPN, BYTE DO_NPN);

Set DIO2 configuration

Isolate_Type: DIO2 Isolate Type

1: Isolated DIO; 0: Non-Isolated DIO

DI_NPN: DIO2 input NPN mode (DI_NPN[7:0])

1: PNP (Source) mode for European rule; 0: NPN (Sink) mode for Japanese rule

DO_NPN: DIO2 output NPN mode

1: PNP (Source) mode for European rule; 0: NPN (Sink) mode for Japanese rule

Return:

TRUE (1): Success; FALSE (0): Fail (driver not work, or hardware problem)

C

APPENDIX C : RAID Installation Guide

C.1 SATA Mode for RAID

Please select SATA device to RAID mode on BIOS menu.
Advanced → SATA Configuration → SATA Mode Selection

Main	Advanced	Chipset	Boo	Security	Save & Exit
SATA Controller(s) [Enabled]					Item Specific Help
SATA Model Selection [AHCI]					

C.2 OS Installation

ECS-9771 is featured with eight SATA, option 1: include four internal SATA, three mSATA and one CFast. Option 2: include three internal SATA, four mSATA and one CFast.

You can select one of SATA ports for OS installation
We used CFast card for Windows 10 OS installation as an example.

C.3 Install All Device Drivers of ECS-9771 System

The instructions are as follows:

1. Install Chipset driver
2. Install Network driver
3. Install ME driver (if available)
4. Install Audio driver
5. Install VGA driver

C.4 Install “Intel Rapid Storage Technology” Software

You can get the software on ECS-9771 driver CD.

Also, you can find latest information and software directly from Intel website.

http://www.intel.com/p/en_US/support/highlights/chpsts/imsm

The RAID environment has been done if you completed the steps above.

C.5 Insert SATA HDD for RAID 1

Please notice, you can use six SATA ports for SATA HDD, except for the CFast port and mSATA slot.

C.6 Create RAID Volume on “Rapid Storage Technology” Software

ECS-9771 is featured with four SATA HDDs for RAID volume, so there are three options for choose on this page. Let’s take RAID 1 as example, please select “RAID 1”.



C.7 Disk Management : Partition the Disk

After RAID 1 volume created, you can see the figure of SATA device allocation.

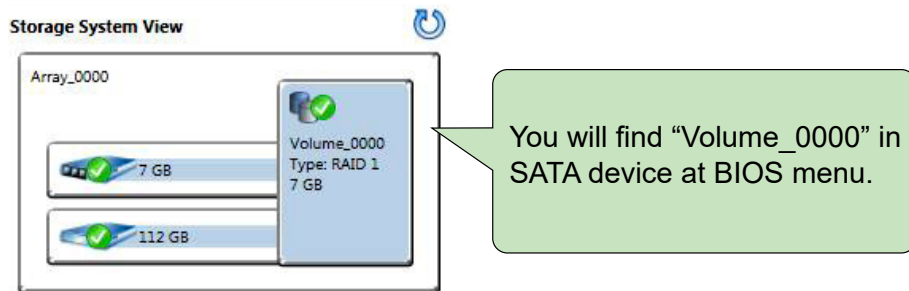

To start Disk Management tool, select "initialize disk."

Then add "Logical Device" for Windows access.

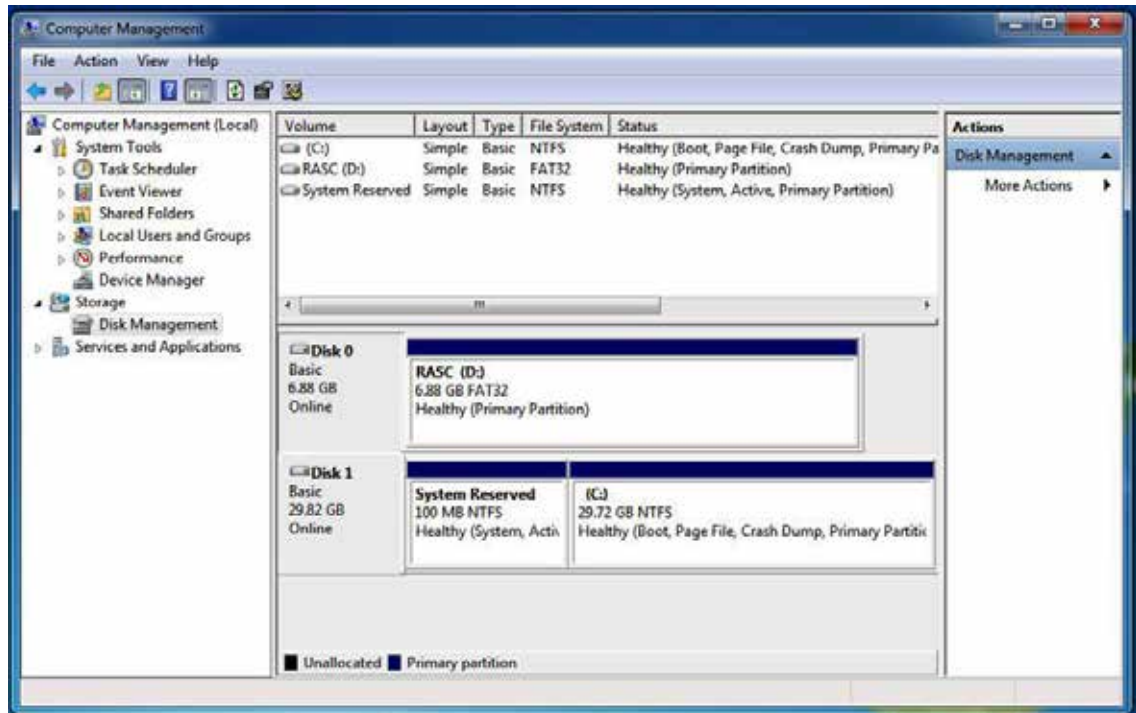

C.8 If One SATA HDD on RAID Volume is Out-of-use

After RAID 1 volume created, you can see the figure of SATA device allocation.

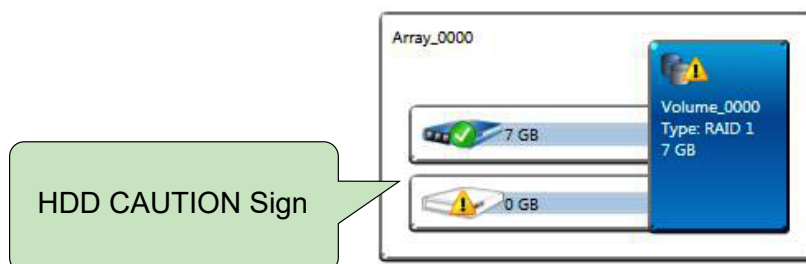

C.9 Recovery and Auto Re-build When Using the SAME RAID HDD

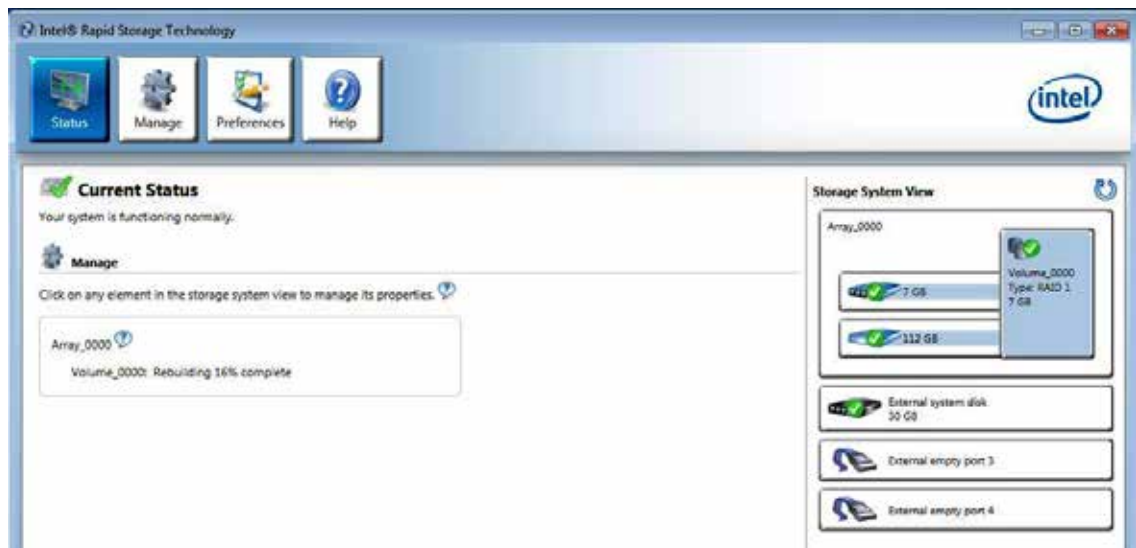

C.10 Recovery and Auto Re-build When Using DIFFERENT RAID HDD

There is a warning will pop-up to ask you if the disk is not a member of original RAID volume.

If you press “Rebuild”, it will replace the broken SATA HDD to the last one SATA HDD of RAID volume.

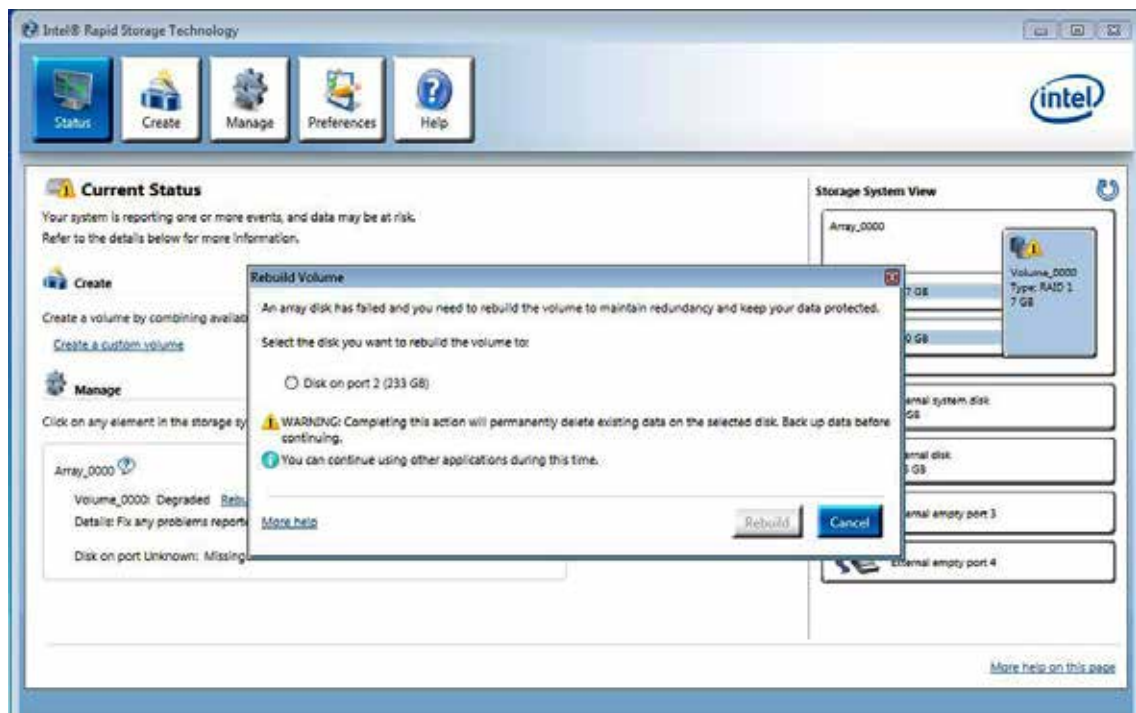

D

APPENDIX D : Power Consumption

Testing Board	ECS-9771
RAM	16GB X 2
USB-1	USB Keyboard Logitech K120
USB-2	USB Mouse Microsoft 1113
USB-3	USB Flash ADATA 3.0 8GB
USB-4	USB Flash ADATA 3.0 8GB
SATA 0	Intel SATA 540S 180GB
SATA 0	Seagate HDD 160GB
LAN 1 (i219)	1.0 Gbps
LAN 2 (i210)	1.0 Gbps
LAN 3-6 (X710-BM2, 10G)	10.0 Gbps
Graphics Output	DP
Power Plan	Balance(Windows7 Power plan)
Power Source	Chroma 62006P-100-25
Test Program	BurnInTest V8.1

D.1 Intel® Core™ i7-6820EQ (8M Cache, 2.80 GHz)

Power on and boot to Win 7 64-bit

CPU	Power Input	Standby Mode		Sleep Mode		Idle Status : CPU usage less 3%	
		Max Current	Max Consumption	Max Current	Max Consumption	Max Current	Max Consumption
Core™ i7-6820EQ	06V	0.950A	05.70W	1.170A	07.02W	4.900A	29.40W
Core™ i7-6820EQ	09V	0.690A	06.21W	0.760A	06.84W	3.530A	31.77W
Core™ i7-6820EQ	12V	0.540A	06.48W	0.630A	07.56W	2.560A	30.72W
Core™ i7-6820EQ	24V	0.290A	06.96W	0.340A	08.16W	1.120A	26.88W
Core™ i7-6820EQ	36V	0.230A	08.28W	0.270A	09.72W	0.790A	28.44W

CPU	Power Input	Run 100% CPU usage without 3D		Run 100% CPU usage with 3D	
		Max Current	Max Consumption	Max Current	Max Consumption
Core™ i7-6820EQ	06V	8.980A	53.88W	9.990A	59.94W
Core™ i7-6820EQ	09V	5.770A	51.93W	6.430A	57.87W
Core™ i7-6820EQ	12V	4.340A	52.08W	4.900A	58.80W
Core™ i7-6820EQ	24V	2.180A	52.32W	2.310A	55.44W
Core™ i7-6820EQ	36V	1.480A	53.28W	1.460A	52.56W

E

APPENDIX E : Supported Memory & Storage List

E.1 Supported Memory List

Testing Board	ECS-9771
Memory Test	version: 5.1
BurnInTest	V8.1

E.2 Test Item

Channel	Memory Test	Burn In	Flash BIOS	Remove Battery
*2	PASS	PASS	PASS	PASS
*1(Socket 1)	PASS	PASS	N/A	PASS
*1(Socket 2)	PASS	PASS	N/A	PASS

E.3 NON-ECC

Brand	Info	Channel	NOTE & S/N	Test Temp. (Celsius)
Transcend	8G 2Rx8 DDR4 2400 SO	*2	TS9CBSESE0000	25°C
		*1(Socket 1)	C96645-0001	25°C
		*1(Socket 2)	C96645-0002	25°C
Transcend	16G 2Rx8 DDR4 2133 SO	*2	TS0CASGSB0000	25°C
		*1(Socket 1)	D20478-0004	25°C
		*1(Socket 2)	D20478-0004	25°C
DSL	DDR4 2133 4GB CL15	*2	D4SS12081SH21A-A	25°C
		*1(Socket 1)	1614-35909	25°C
		*1(Socket 2)	1614-35910	25°C
innodisk	4GB DDR4 SODIMM	*2	M4S0-4GSSNCRG	25°C
		*1(Socket 1)	M0S11601080040001	25°C
		*1(Socket 2)	M0S11601080040002	25°C
innodisk	8GB DDR4 2133 W/T SODIMM	*2	M4S0-8GSSO5RG	25°C
		*1(Socket 1)	M0S21606010020001	25°C
		*1(Socket 2)	M0S21606010020002	25°C
innodisk	16GB DDR4 2133 W/T SODIMM	*2	M4S0-AGS1O5RG	25°C
		*1(Socket 1)	M0S11608040020001	25°C
		*1(Socket 2)	M0S11608040020002	25°C
Kingston	16GB 2Rx8 2Gx64-Bit PC4-2133	*2	KVR21S15D8/16	25°C
		*1(Socket 1)	BKMM1641607	25°C
		*1(Socket 2)	BKMM1661618	25°C

E.4 ECC

Brand	Info	Channel	NOTE & SN	Test Temp. (Celsius)
Transcend	16GB ECC Wild temp.	*2		85°C
		*1(Socket 1)	C94147-0001	85°C
		*1(Socket 2)	C94147-0002	85°C
Transcend	16G 2Rx8 DDR4 2133 ECCSO	*2		25°C
		*1(Socket 1)	C69768-0063	25°C
		*1(Socket 2)	C69768-0064	25°C
Transcend	4G 1Rx8 DDR4 2133 ECCSO	*2		25°C
		*1(Socket 1)	C71337-0021	25°C
		*1(Socket 2)	C71337-0022	25°C
DSL	DDR4 2133 4GB CL15 ECC	*2	D4XS12081SH21A-A	25°C
		*1(Socket 1)	1604-76367	25°C
		*1(Socket 2)	1604-76368	25°C
DSL	DDR4 2133 8GB CL15 ECC	*2	D4XS12082SH21A-A	25°C
		*1(Socket 1)	1549-39956	25°C
		*1(Socket 2)	1549-39961	25°C
DSL	DDR4 2133 16GB CL15 ECC	*2	D4XS1G082SH21A-B	25°C
		*1(Socket 1)	1604-76363	25°C
		*1(Socket 2)	1604-76362	25°C
innodisk	4GB DDR4 2133 ECC	*2	M4D0-4GSSPCRG	25°C
		*1(Socket 1)	M0S11601080080001	25°C
		*1(Socket 2)	M0S11601080080002	25°C
innodisk	8GB DDR4 2133 ECC	*2	M4D0-8GS1PCRG	25°C
		*1(Socket 1)	M0S11601080100001	25°C
		*1(Socket 2)	M0S11601080100002	25°C
innodisk	8GB DDR4 2133 ECC	*2	MSD0-8GSSQCRG	25°C
		*1(Socket 1)	M0S11601080090001	25°C
		*1(Socket 2)	M0S11601080090002	25°C
innodisk	16GB DDR4 2133 ECC	*2	M4D0-AGS1QCFG	25°C
		*1(Socket 1)	M0S11601080110001	25°C
		*1(Socket 2)	M0S11601080110002	25°C

E.5 Supported Storage Device List

Type	Brand	Model	Capacity
mSATA	Intel	Intel-310 SSDMAEMC080G2	80GB
	innodisk	mSATA 3ME3 DEMSR-64GD09BW2DC	64GB
		mSATA 3ME3 DEMSR-A28D09BW2DC	128GB
		mSATA 3ME3 DEMSR-B56D08BWBQC	256GB
SATA SSD	Transcend	SSD420 TS128GSSD420I	128GB
		SSD420 TS256GSSD420I	256GB
		SSD370 TS64GSSD370	64GB
	Intel	SSD 540s SSDSC2KW180H6	180GB
		SSD E 5400s SSDSC2KR120H6	120GB
		SSD 530 SSDSC2BW120A4	120GB
	innodisk	3MG2-P DGS25-64GD81BW1QC	64GB
		3MG2-P A28D81BW1QC	128GB
		3MG2-P DGS25-B56D81BW3QC	120GB
SATA HDD	TOSHIBA	MQ01ABF050	500GB
	HGST	Z5K500.B-500	500GB

** If more help is needed, please contact Vecow technical support **



For further support information, please visit www.vecow.com

This document is released for reference purpose only.

All product offerings and specifications are subject to change without prior notice.

No part of this publication may be reproduced in any form or by any means, electric, photocopying, or recording, without prior authorization from the publisher.

The rights of all the brand names, product names, and trademarks belong to their respective owners.

© Vecow Co., Ltd. 2021. All rights reserved.